



DISPLAY

Your Complete
Visual Communication
Display Guide

#1
Roller Banners

#17
Tension Banners

#27
Flags

#35
Outdoor

#47
POS Signage

#61
Counters

#75
Backwalls

#91
Modular Solutions

#105
Literature Holders

#109
Cases

#113
Lighting

Display solutions are one of the most popular and impactful visual communication media on the market.

Whether it is for frequent and regular use or for a durable fixed arrangement, a multitude of solutions exists and for any budget.

To successfully communicate your messages and brand at point of sale, shows and events it is essential to understand:

- The environment in which the display will be exhibited.
- Whether the display will be renewed and how frequently.
- The quality appropriate to the event and relative to the desired budget.
- How to accessorise the product to increase its functionality.
- How to stand out from the competition with high-end, original solutions that distinguish your brand from the competition.

This comprehensive guide offers you a wide choice of products. We will help you find the best solution suited to your needs.



New product



Custom size available



Best seller



Made in Europe



1 Year hardware guarantee



Use with fabric graphic



5 Year hardware guarantee



Use with PVC graphic



Lifetime hardware guarantee



Use with self-adhesive graphic



Comes with a bag



Use with rigid panel graphic



Illuminated product



Direct printing onto hardware

Roller Banners

Simple, striking, stylish – banners are still one of the most popular, effective and easy ways to promote your business and get your message across in a wide variety of environments.

With one of the most comprehensive ranges on the market, our banners are designed to suit every budget and fit all situations. From single to frequent use and if you need it, the ability to change your graphics.



Roller Banners are one of the most popular and effective communication tools available.

Using our solutions will exceed your expectations, whatever your needs may be, from desktop, retail outlets, exhibition stands to the office environment.

We have one of the widest ranges of both economy and premium Roller Banners on the market, with widths ranging from 600mm to 3000mm! It's therefore important to choose the right one for your needs. Here is a quick guide explaining what you should consider.



Before choosing your Roller Banner, ask yourself:

1. Where will it be positioned: indoors or outdoors?
2. How often will your banner be used
- Occasionally or daily?
3. How much space is available for the banner?
4. What is the right size to attract your audience?
- It is important to choose the right size without over-crowding your display area.
5. Will you need to change the graphic? - Are the messages consistent or will you need to alternate messages for different occasions or offers?
6. What is the right material for your needs?
- Check the environment and select the right materials to meet your needs - banner vinyl, polyester or textile fabric.
7. What is your budget?

Top graphic rail attachments explained



Snap rail



Premium dual action self-adhesive and snap rail



Self-adhesive rail



SmartFix rail (snap / self-adhesive)

We recommend using PVC media when using the adhesive rail

Base graphic attachment explained



Hook and loop strip



Cassette

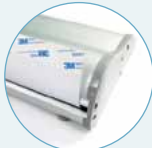

Self-adhesive leader



Sliding system

If you need to change your graphic often then we recommend choosing the cassette banner system

Transport bag types explained



Simple nylon



Nylon padded



Premium EVA Semi rigid



Nylon with padded inner protection (double skin)



Padded nylon with side opening and foam reinforced ends

Bags are provided for all Roller Banners and include a business card holder and carry handles for ease of transportation



Revolution



Uniquely designed roller banner with revolutionary style and design. Gloss white plastic injected banner with dark grey plastic under carriage to give the appearance of floating when displayed.

- Material :** Injection moulded plastic
- Rail :** Snap rail with self-adhesive slider mechanism
- Pole :** White hybrid telescopic pole
- Leader :** Self-adhesive leader
- Graphic :** Single-sided
- Feet :** Adjustable
- Bag :** Premium EVA semi rigid

850 mm	UB161-850	📏 1630/2260 (h) x 900 (w) x 225 (d) mm
--------	-----------	----------------------------------------



White hybrid telescopic pole



Adjustable feet



Grey plastic ends and undercarriage



Snap rail with adhesive slider mechanism

Exclusive design ↷



Ultra-durable EVA bag for better protection

Premium

Original+



Adjustable height premium roller banner in a variety of sizes up to three meters. Can be made in black or to custom sizes at an additional cost. Also features a linear channel which accepts a variety of optional extra accessories for a multi-functional display.

- Material :** Aluminium and plastic
- Rail :** Premium dual action self-adhesive and snap rail with secure end caps
- Pole :** Hybrid adjustable height telescopic pole
- Leader :** Self-adhesive sliding leader
- Graphic :** Single-sided
- Feet :** Adjustable
- Bag :** Padded nylon with side opening and foam reinforced ends

600 mm	UB322-600C1	Ⓞ 1590/2230 (h) x 640 (w) x 195 (d) mm
800 mm	UB322-800C1	Ⓞ 1590/2230 (h) x 840 (w) x 195 (d) mm
1000 mm	UB322-1000C1	Ⓞ 1590/2230 (h) x 1040 (w) x 195 (d) mm
1200 mm*	UB322-1200C1	Ⓞ 1590/2230 (h) x 1240 (w) x 195 (d) mm
1500 mm*	UB322-1500C1	Ⓞ 1590/2230 (h) x 1540 (w) x 195 (d) mm
2000 mm*	UB322-2000C1	Ⓞ 1590/2230 (h) x 2040 (w) x 195 (d) mm
2400 mm**	UB322-2400C1	Ⓞ 1590/2230 (h) x 2440 (w) x 195 (d) mm
3000 mm**	UB322-3000C1	Ⓞ 1590/2230 (h) x 3040 (w) x 195 (d) mm

* Comes with 2 Poles
** Comes with 3 Poles



Hybrid adjustable height telescopic pole



Premium dual action self-adhesive and snap rail



Available in eight sizes up to 3m wide

Impressive durable everyday banner



Custom sizes also available on request

Available in eight different widths from 600mm to up to three meters!

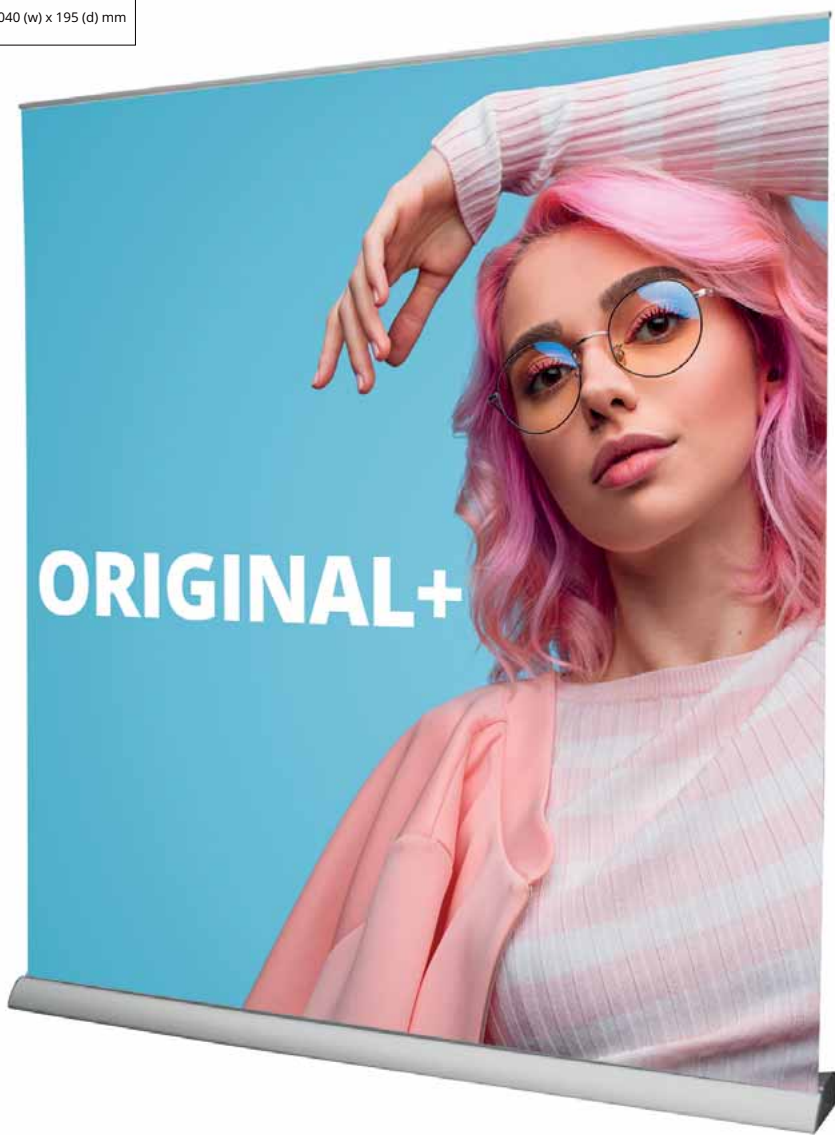

Accessorise Your Banner

Choose from our optional accessories to make your banner multi-functional and more visible.

Also compatible with Original+, Barracuda, Imagine+ and Excaliber2 roller banners



Frame attaches securely to the banner base

More than just a roller banner



Leaflet holders available in three portrait sizes, DL, A4 and A5

Mix and match your multiple accessories

Shelf post	LNBA-02
Shelf	PBA-02
Post for acrylic leaflet holders	LNBA-DLP
Acrylic leaflet holder post (DL size)	AH5DLP
Acrylic leaflet holder post (A4 size)	AH5A4P
Acrylic leaflet holder post (A5 size)	AH5A5P
Steel leaflet holder	LNBA-01
iPad/LCD Screen mount*	LNBA-03
iPad holder (black)*	IPAD-CHU-B
iPad holder (white)*	IPAD-CHU-W

* LCD screen and iPad are not included and not available to purchase. LCD mount available on Excaliber2 banners only - 5kg max screen weight.



Steel leaflet holder



Acrylic leaflet holder



Screen mount for LCD screen or iPad*



Shelving

Premium



Barracuda



Stylish adjustable height premium roller banner with large internal graphic housing and tensioner. Stylish pinstripe detailing on case front. Supports Linear accessories

- Material :** Aluminium and plastic
- Rail :** Premium dual action self-adhesive and snap rail with secure end caps
- Pole :** Hybrid adjustable height telescopic pole
- Leader :** Self-adhesive sliding leader
- Graphic :** Single-sided
- Feet :** Adjustable
- Bag :** Padded nylon with side opening and foam reinforced ends

800 mm	WH321C-800A3	⊗ 2210 (h) x 860 (w) x 200 (d) mm
1000 mm	WH321C-100A3	⊗ 2210 (h) x 1060 (w) x 200 (d) mm
1200 mm	WH321C-1200A3	⊗ 2210 (h) x 1260 (w) x 200 (d) mm
1500 mm	WH321C-1500A3	⊗ 2210 (h) x 1560 (w) x 200 (d) mm
2000 mm	WH321C-2000A3	⊗ 2210 (h) x 2060 (w) x 200 (d) mm
2400 mm	WH321C-2400A3	⊗ 2210 (h) x 2460 (w) x 200 (d) mm

Adjust the banner height from 1605 up to 2210mm



Imagine+



Cassette banner for quick change graphics. Adjustable feet and height. Features a linear channel which accepts a variety of optional extra accessories for multi-functional display.

- Material :** Aluminium and plastic
- Rail :** Snap rail with end caps
- Pole :** Hybrid adjustable height telescopic pole
- Leader :** Cassette banner with adhesive leader
- Graphic :** Single-sided
- Feet :** Adjustable
- Bag :** Padded nylon with side opening and foam reinforced ends

850 mm	UB502C-850-01	⊗ 2220 (h) x 910 (w) x 215 (d) mm
1000 mm	UB502C-1000-01	⊗ 2220 (h) x 1060 (w) x 215 (d) mm

Accessories :

Replacement cassette - 850 mm	UB175-850-01
Replacement cassette - 1000 mm	UB175-1000-01

Easy to use stylish cassette banner



Hybrid adjustable height telescopic pole



Cassette banner for easy change of graphics



Orient+



Front-loading graphic that pulls up from the front of the base ensuring your brand message has maximum visibility from floor to rail. Market leading roller banner

- Material :** Aluminium and plastic
- Rail :** Premium dual action self-adhesive and snap rail with secure end caps
- Pole :** Hybrid adjustable height telescopic pole
- Leader :** Self-adhesive sliding leader, optional hook and loop strip
- Graphic :** Single-sided
- Feet :** Adjustable
- Bag :** Padded nylon with side opening and foam reinforced ends

800 mm	WH353-800-003	📏 1595/2220 (h) x 840 (w) x 185 (d) mm
850 mm	WH353-850-003	📏 1595/2220 (h) x 890 (w) x 185 (d) mm
1000 mm	WH353-1000-003	📏 1595/2220 (h) x 1040 (w) x 185 (d) mm
1200 mm*	WH353-1200-003	📏 1595/2220 (h) x 1240 (w) x 185 (d) mm
1500 mm*	WH353-1500-003	📏 1595/2220 (h) x 1540 (w) x 185 (d) mm
2000 mm*	WH353-2000-003	📏 1595/2220 (h) x 2040 (w) x 185 (d) mm



* Comes with 2 Poles



Sleek and elegant design

Merlin



Interchangeable cassette with telescopic pole allows you to change graphics easily and quickly. Ability to store the old graphic in the cassette and re-use it later.

- Material :** Aluminium and plastic
- Rail :** Snap rail
- Pole :** Hybrid adjustable height telescopic pole
- Leader :** Cassette banner with adhesive leader
- Graphic :** Single-sided
- Feet :** Adjustable
- Bag :** Padded nylon with side opening and foam reinforced ends

850 mm	UB160-850-01	📏 1655/2315 (h) x 915 (w) x 195 (d) mm
1000 mm	UB160-1000-01	📏 1655/2315 (h) x 1065 (w) x 195 (d) mm

Accessories :

Replacement cassette - 850 mm	UB175-850-01
Replacement cassette - 1000 mm	UB175-1000-01



Floor to rail graphic visibility

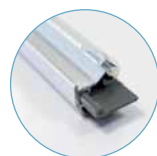

Premium dual action self-adhesive and snap rail

Hybrid adjustable height telescopic pole



Graphics are easily updated using changeable cassettes



Adjustable feet



Side opening padded bag with foam reinforced ends



Change display in seconds

Standard

↩ Snap rail with end caps



Delta Lite

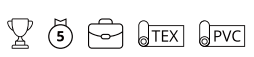

Elegant aluminium banner with chrome finished end covers that combines great design with stability whilst remaining lightweight.

- Material :** Aluminium and plastic
- Rail :** Snap rail with end caps
- Pole :** Hybrid adjustable height telescopic pole
- Leader :** Self-adhesive
- Graphic :** Single-sided
- Feet :** Adjustable
- Bag :** Padded nylon

800 mm	UB205-800-004	⊗ 1625/2224 (h) x 853 (w) x 203 (d) mm
850 mm	UB205-850-004	⊗ 1625/2224 (h) x 903 (w) x 203 (d) mm
1000 mm	UB205-1000-004	⊗ 1625/2224 (h) x 1053 (w) x 203 (d) mm



Pioneer



The most economical mid-range roller banner on the market. Moulded polymers provide a glossy white finish and modern high-end finished look.

- Material :** Plastic base, aluminium pole / rail
- Rail :** Snap rail with end caps
- Pole :** Aluminium three-part bungee pole
- Leader :** Self-adhesive
- Graphic :** Single-sided
- Feet :** Adjustable
- Bag :** Padded nylon

800 mm	UB147-800	⊗ 2095 (h) x 845 (w) x 225 (d) mm
850 mm	UB147-850	⊗ 2095 (h) x 895 (w) x 225 (d) mm
1000 mm	UB147-1000	⊗ 2095 (h) x 1045 (w) x 225 (d) mm



Mosquito

Giant Mosquito and Mosquito banners offer classic styling with durability - ideal for any indoor environment. They come with a padded bag for protective transportation and are available in a large choice of sizes.

They continue to be two of the best selling roller banners on the market and great display solutions.



Accessorise your roller banner with powerspot LED lighting (PS800-LED)

Mosquito



One of the most popular banners in its range with snap rail for quick and easy graphic assembly. Lightweight and easy to transport.

- Material :** Aluminium, plastic
- Rail :** Snap rail
- Pole :** Aluminium three-part bungee pole
- Leader :** Self-adhesive
- Graphic :** Single-sided
- Feet :** Twin, twist-out feet
- Bag :** Nylon with padded inner protection (double skin)

800 mm	UB197	⊗ 2105 (h) x 860 (w) x 285 (d) mm
850 mm	UB196	⊗ 2105 (h) x 910 (w) x 285 (d) mm
1000 mm	UB197-1000	⊗ 2105 (h) x 1060 (w) x 285 (d) mm
1200 mm*	UB197-1200	⊗ 2105 (h) x 1260 (w) x 285 (d) mm
1500 mm*	UB197-1500	⊗ 2105 (h) x 1560 (w) x 285 (d) mm
2000 mm*	UB197-2000	⊗ 2105 (h) x 2060 (w) x 285 (d) mm

* Comes with two poles



Available in six widths!

Giant Mosquito



All the advantages of the Mosquito roller banner but with the advantage of extending up to three meters high!

- Material :** Aluminium
- Rail :** Snap rail
- Pole :** Telescopic pole that can be set at various heights up to 3m
- Leader :** Self-adhesive
- Graphic :** Single-sided
- Feet :** Twin, twist-out large feet
- Bag :** Nylon with padded inner protection (double skin)

850 mm	UB300-850	⊗ 1705/3100 (h) x 869 (w) x 400 (d) mm
1000 mm	UB300-1000	⊗ 1705/3100 (h) x 1019 (w) x 400 (d) mm
1500 mm*	UB300-1500	⊗ 1705/3100 (h) x 1519 (w) x 400 (d) mm
2000 mm*	UB300-2000	⊗ 1705/3100 (h) x 2019 (w) x 400 (d) mm

* Comes with two poles



Extends up to 3m high!



Telescopic pole



Rigidising bracket increases banner longevity. Insertion hole for guiding pole into correct position

Economy



Sleek design with tension winder

Full graphic visibility

Prism

① 📁 📄 TEX 📄 PVC

Strong and stylish oval shaped full graphic banner with self-adhesive rail and tensioner.

- Material :** Aluminium, plastic
- Rail :** Self-adhesive
- Pole :** Aluminium three-part bungee pole
- Leader :** Self-adhesive
- Graphic :** Single-sided
- Feet :** Twin, twist-out feet
- Bag :** Padded nylon with side opening

800 mm	UB123-800-01	📏 2080 (h) x 830 (w) x 350 (d) mm
850 mm	UB123-850-01	📏 2080 (h) x 880 (w) x 350 (d) mm
1000 mm	UB123-1000-01	📏 2080 (h) x 1030 (w) x 350 (d) mm



Snap rail

Full graphic visibility

Liberty

① 📁 📄 TEX 📄 PVC

Strong and stylish full graphic banner with oval shaped end covers for a unique look.

- Material :** Aluminium, plastic end caps on rail
- Rail :** Snap rail
- Pole :** Aluminium three-part bungee pole
- Leader :** Self-adhesive
- Graphic :** Single-sided
- Feet :** Twin, twist-out feet
- Bag :** Padded nylon with side opening

800 mm	UB122-800-01	📏 2080 (h) x 830 (w) x 350 (d) mm
850 mm	UB122-850-01	📏 2080 (h) x 880 (w) x 350 (d) mm
1000 mm	UB122-1000-01	📏 2080 (h) x 1030 (w) x 350 (d) mm



Our most economical aluminium roller banner

Wasp

🏆 ① 📁 📄 TEX 📄 PVC

Entry level banner, ideal for short-term events or displays. Lightweight, easy to carry and recycle once finished with.

- Material :** Aluminium, plastic end caps on rail and feet tips
- Rail :** Snap rail
- Pole :** Aluminium three-part bungee pole
- Leader :** Self-adhesive
- Graphic :** Single-sided
- Feet :** Twin, twist-out feet
- Bag :** Simple nylon

800 mm	UB204-800-03	📏 2080 (h) x 815 (w) x 320 (d) mm
850 mm	UB204-850-03	📏 2080 (h) x 865 (w) x 320 (d) mm
1000 mm	UB204-1000-03	📏 2080 (h) x 1015 (w) x 320 (d) mm



Also available in sizes up to 1.5m

Grasshopper

🏆 ① 📁 📄 TEX 📄 PVC

Popular lightweight economy banner with self-adhesive rail. Comes in five widths up to 1.5 meters.

- Material :** Aluminium, plastic feet tips
- Rail :** Self-adhesive
- Pole :** Aluminium bungee pole
- Leader :** Self-adhesive
- Graphic :** Single-sided
- Feet :** Twin, twist-out feet
- Bag :** Padded nylon bag

800 mm	UB191	📏 2105 (h) x 860 (w) x 285 (d) mm
850 mm	UB193	📏 2105 (h) x 910 (w) x 285 (d) mm
1000 mm	UB191-1000	📏 2105 (h) x 1060 (w) x 285 (d) mm
1200 mm	UB191-1200	📏 2105 (h) x 1260 (w) x 285 (d) mm
1500 mm	UB191-1500	📏 2105 (h) x 1560 (w) x 285 (d) mm

Mantis



A unique roller banner offering a top rail with choice. This popular entry-level banner has a weighted base for optimum stability when deployed in busy environments.

- Material :** Aluminium, plastic end caps on rail
- Rail :** SmartFix (snap/self-adhesive)
- Pole :** Aluminium three-part bungee pole
- Leader :** Self-adhesive
- Graphic :** Single-sided
- Feet :** Twin, twist-out feet
- Transport:** Padded nylon bag with side opening

600 mm*	UB216-600	⊗ 1685/2085 (h) x 620 (w) x 280 (d) mm
800 mm	UB216-800	⊗ 2085 (h) x 870 (w) x 280 (d) mm
850 mm	UB216-850	⊗ 2085 (h) x 1020 (w) x 280 (d) mm
1000 mm	UB216-1000	⊗ 2085 (h) x 1220 (w) x 280 (d) mm

* The 600 mm version comes with:
 - a bungee pole in three parts (1600 mm high graphic)
 - a pole extension (2000 mm high graphic)



Element



Economical white ABS roller banner which is ideally suited for retail environments

- Material :** Plastic, aluminium rail
- Rail :** Snap rail
- Pole :** Aluminium three-part bungee pole
- Leader :** Self-adhesive
- Graphic :** Single-sided
- Feet :** Twin, twist-out feet
- Bag :** Simple nylon

800 mm	UB146-800	⊗ 2090 (h) x 830 (w) x 85 (d) mm
850 mm	UB146-850	⊗ 2090 (h) x 880 (w) x 85 (d) mm
1000 mm	UB146-1000	⊗ 2090 (h) x 1030 (w) x 85 (d) mm



White ABS base



Easy to assemble



Rigidising bracket

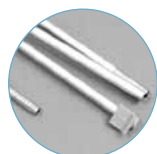

Pole extension for 600mm version only



White base

The most economical banner on the market

Double-sided

Dragonfly 2



Economical double-sided roller banner with pole storage in base.

- Material :** Aluminium, plastic end caps on rail
- Rail :** Snap rail with end caps
- Pole :** Aluminium three-part bungee pole
- Leader :** Self-adhesive
- Graphic :** Double-sided
- Feet :** Twin, twist-out feet
- Bag :** Padded nylon

850 mm	UB199-850-01	Ⓞ 2105 (h) x 890 (w) x 395 (d) mm
1000 mm	UB199-1000-01	Ⓞ 2105 (h) x 1040 (w) x 395 (d) mm



Edge 2



Mid-range, double-sided elegant roller banner with stylish chromed end covers. Self-supporting base to maximize floor space.

- Material :** Aluminium, chrome base end covers
- Rail :** Snap rail with end caps
- Pole :** Aluminium three-part bungee pole
- Leader :** Self-adhesive
- Graphic :** Double-sided
- Bag :** Padded nylon

850 mm	UB200-850	Ⓞ 2100 (h) x 890 (w) x 190 (d) mm
1000 mm	UB200-1000	Ⓞ 2100 (h) x 1040 (w) x 190 (d) mm



Excaliber 2



Great premium double-sided banner which can be accessorised using it's linear channel with iPad holders, shelving and leaflet holders.

- Material :** Aluminium, polycarbonate end caps on rail
- Rail :** Premium dual action self-adhesive and snap rail with secure end caps
- Pole :** Hybrid telescopic pole
- Leader :** Self-adhesive sliding leader
- Graphic :** Double-sided
- Feet :** Adjustable
- Bag :** Padded nylon with side opening and foam reinforced ends

800 mm	WH311C-800A3	Ⓞ 1600/2220 (h) x 860 (w) x 275 (d) mm
1000 mm	WH311C-1000A3	Ⓞ 1600/2220 (h) x 1060 (w) x 275 (d) mm
1200 mm*	WH311C-1200A3	Ⓞ 1600/2220 (h) x 1260 (w) x 275 (d) mm
1500 mm*	WH311C-1500A3	Ⓞ 1600/2220 (h) x 1560 (w) x 275 (d) mm
2000 mm*	WH311C-2000A3	Ⓞ 1600/2220 (h) x 2060 (w) x 275 (d) mm
2400 mm**	WH311C-2400A3	Ⓞ 1600/2220 (h) x 2460 (w) x 275 (d) mm

*Comes with two poles **Comes with three poles



Stellar



Uniquely designed desktop roller banner. Ideally suited for displaying on tables or counters and retails at a great low price.

- Material :** White injected moulded plastic
- Rail :** Self-adhesive
- Pole :** White two-part pole
- Leader :** Self-adhesive
- Graphic :** Single-sided
- Bag :** Bag not included

Stellar A4	UB162-A4	⊗ 320 (h) x 231 (w) x 78 (d) mm
Stellar A3	UB162-A3	⊗ 444 (h) x 312 (w) x 78 (d) mm



Liberty Mini



Full graphic, compact, versatile and lightweight desktop roller banner. Height extendable from 1200mm to 1600 mm when using extension pole.

- Material :** Aluminium, plastic end caps on rail
- Rail :** Snap rail
- Pole :** Two Part-pole, height 400 - 800mm
Four Part pole, height 1200 - 1600mm
- Leader :** Self-adhesive
- Graphic :** Single-sided
- Bag :** Padded nylon

Liberty Mini A4	UB122-400	⊗ 450/850 (h) x 430 (w) x 125 (d) mm
Extension Pole 1200-1600mm	EP-MINI	⊗ 1200-1600 (h) mm



Breeze



Ideal as mini table roller banner or promotional gift. Ultra-light and easy to assemble.

- Material :** Aluminium, plastic end caps on rail
- Rail :** Self-adhesive
- Pole :** Two-part pole
- Leader :** Self-adhesive
- Graphic :** Single-sided
- Bag :** Simple nylon

Breeze A4	WH360	⊗ 335 (h) x 238 (w) x 80 (d) mm
Breeze A3	WH361	⊗ 440 (h) x 332 (w) x 82 (d) mm



Two-part pole



Modular

Aero+



Modular cassette roller banner system, adjustable in height, width and re-positionable at different angles. Multiple configurations possible with additional banners.

- Material :** Aluminium and plastic
- Rail :** Snap rail
- Pole :** Graphics adjustable to five fixed points on post*
- Leader :** Self-adhesive
- Graphic :** Single-sided
- Feet :** Fold-out feet for ease of transportation
- Bag :** Padded nylon

Cassette 1000 mm	UB222-1000	⊙ 1000 (w) mm
Cassette 1500 mm	UB222-1500	⊙ 1500 (w) mm
Cassette 2000 mm	UB222-2000	⊙ 2000 (w) mm
Base and post	UB222-P	⊙ 2120 (h) x 500 (w) x 500 (d) mm

* 1310/1510/1710/1910/2110mm - depending on configuration

Multiple configurations

Height adjustable



Folding feet



Adjustable collar on telescopic poles



Unique cassette locking system



Graphic tensioner

Optional LED lighting



Accessorise your Aero+

Universal Clamp for Aero+	UB222-01
Bracket for leaflet holder	FX839
Leaflet holder DL/A5/A4	AH5DLP/A5P/A4P
Bracket for iPad*	FX837
iPad* tablet holder (black / white)	IPAD-CHU-W/B
Bracket for shelf	FX838
Shelf - round / triangle / square	LN133-R/T/S

* iPad not included



Bracket for leaflet holder



Bracket for iPad*



Bracket for shelf



Universal clamp for Aero+



Leaflet holder in DL, A4 and A5 sizes



iPad holder in white or black finish



Shelf - comes in 3 shapes; round, triangle and square



Tension Banners

Our most versatile range of banners, designed to fit into any space and provide a seamless image and backdrop that gives maximum impact.

Our Tension Banner systems can be modular and linkable to create any size and shape, or simple stand-alone units, making them versatile and easy to use. They are also available in a wide range of substrates.



Perfect for situations where you need to change your message frequently, such as a retail or a show environment.

Our Tension Banners are a popular and cost-effective solution that allow for the quick and easy changeover of graphics. Many also come supplied with sturdy nylon bags for ease of transport.

Our banners come in a wide variety of sizes, from a height of 1500 to 2900mm, and widths ranging from 300 to 1600mm. For more flexible solutions, our Uno and Stealth banners can be linked to create modular systems that can be re-configured to make the best use of the space you have.

Choosing the right Tension Banner:

1. Will your banner need to be packed up and moved regularly?
2. How often will the banner be re-used and need a change of graphic?
3. What is the size of the footprint that you need to use your banner within?
4. Do you have any height restrictions? As our banners can be provided in a range of heights to take advantage of vertical spaces or limitations.
5. Are you deploying in high traffic environments? As our banners are supplied with a range of bases to suit each space.
6. Finally, determine your budget and choose the best quality to suit your needs.

Graphic Attachments



Snap rail



Zip cover



Panel recess



Aluminium frame for silicone edged graphics



Eyelets



Adhesive slider

Vector LED Kit 125mm



Illuminate to communicate! This robust free-standing LED frame perfectly suits interior displays that need to be regularly updated to keep up with changing trends.

- Material :** Aluminium
- Profile width :** 125mm
- Assembly :** Screw-in bracket, Allen key
- Graphic attachment :** SEG 3mm
- Graphic area :** Single-sided (one side printed with block-out rear) double-sided (both sides printed)
- Mounting :** Free-standing with flat retail feet (included)

2x1 LED Kit	VLB125-2x1	⊗ 2005 (h) x 1000 (w) x 550 (d) mm
2x2 LED Kit	VLB125-2x2	⊗ 2005 (h) x 2000 (w) x 550 (d) mm
2x3 LED Kit	VLB125-2x3	⊗ 2005 (h) x 3000 (w) x 550 (d) mm
Custom sizes	VLB125-CUSTOM	⊗ Custom



Slimline transformer



360mm LED strip



Cabling system



VLB125-2x3

I deal for shop advertisement



VLB125-2x1

Available in three standard sizes

Vector Kit 50mm



Robust aluminium free-standing frame, packs down for ease of transportation and available in a wide range of sizes accommodating a SEG graphic creating the perfect look for any retail scenario.

- Material :** Aluminium
- Profile depth :** 50mm
- Assembly :** Push-button connector, Allen key
- Graphic attachment :** SEG 3mm
- Graphic area :** Single or double-sided
- Mounting :** Free-standing with flat feet (included)

2x1Kit	VKF-2x1	⊗ 2005 (h) x 1000 (w) x 350 (d) mm
2x2 Kit	VKF-2x2	⊗ 2005 (h) x 2000 (w) x 350 (d) mm
2x3 Kit	VKF-2x3	⊗ 2005 (h) x 3000 (w) x 350 (d) mm
Custom sizes	VKF-CUSTOM	⊗ custom

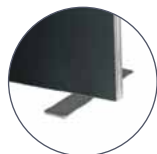

Flat feet included



Fabric graphic with silicone edge gasket (SEG)



Screw different frames together



Assembly of angled sections with push-button



VKF-2x2

Connect multiple kits according to your needs



VKF-2x1

NEW New profile design



Stealth



The portability of a banner stand with the flexibility of a modular display system. Used singularly or link using flexible panels to create graphic walls that can be curved to different angles.

- Material : Aluminium
- Assembly : Twist and Lock
- Graphic attachment : Magnetic
- Graphic area : Single-sided or double-sided (straight configuration only)
- Mounting : Free-standing

Stealth 800 mm	UB106	Ⓞ 2115 (h) x 800 (w) x 350 (d) mm
----------------	-------	-----------------------------------

Accessories :

Shelf	LNST-002	Ⓞ N/A
Acrylic Literature Holder DL/A5/A4	LNST-DLP/A5P/A4P	Ⓞ N/A
LCD Screen / iPad Bracket*	UB106-SMK1	Ⓞ N/A
Design iPad Holder* Black/White	IPAD-CHU-B/W	Ⓞ 310 (h) x 225 (w) x 20 (d) mm
300 mm Flexi joining kit	UB106-004	Ⓞ N/A
600 mm Flexi joining kit	UB106-001	Ⓞ N/A



Lcd screen / iPad bracket*



Thermoformed shelf



Design iPad holder*



Acrylic literature holder

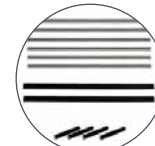

Flexi joining panel kits



Optional LED lighting
PS950/1000-LED-BDLK
LED-FLOOD-ARM-BDLK
LED-STRIP-ARM-BDLK



Easy magnetic linking panels



Reconfigure and angle to maximise your display space



Vector Retail Kit 125mm Lightbox



Available from Spring 2019



In retail where appearance is everything, styling combined with an ultra stable base complements this SEG graphic lightbox.

Material : Black aluminium frame, aluminium-steel base

Profile width : 125mm

Assembly : Screw-in bracket, Allen key

Graphic attachment : SEG 3mm

Graphic area : Single-sided (one side printed with blockout rear)
double-sided (both sides printed)

Mounting : Free-standing with retail base (included)

800 mm LED Kit	VLB125-18X08-B-01	📏 1882 (h) x 800 (w) x 350 (d) mm
1000 mm LED Kit	VLB125-20X10-B-01	📏 2082 (h) x 1000 (w) x 350 (d) mm

Perfect combination between stylish look and stability

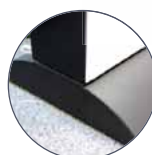

Black end caps



LED 360 mm strip



Adjustable feet under the base

IllumiGo™ LED Lightbox in a Box!



Available from Spring 2019



Portable LED lightbox comes in a compartmented box with handle for ease of transportation. Tool-free assembly, pre-assembled LED lighting, stabilising feet and lightweight white powder-coated aluminium frame.

Material : White aluminium frame

Profile width : 100mm

Assembly : Tool-free

Graphic attachment : SEG 3mm

Graphic area : Single-sided (one side printed with block-out rear)
double-sided (both sides printed)

Mounting : Free-standing with pre-assembled feet

IllumiGo™ LED Lightbox	ILLGO-2X1	📏 2000 (h) x 1000 (w) x 400 (d) mm
------------------------	-----------	------------------------------------

Packs away in to protective box with carry handle. Easy to transport or store



Compartmented transportation box



Quick and easy tool-free assembly

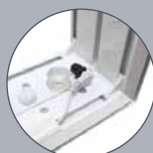

Pre-assembled LED lighting

Tool-free with pre-assembled LED lighting and feet

Formulate Monolith



This monolithic lightweight structure is mounted on a sturdy metal base for extra stability, hinged for ease of transportation from sizes 900mm wide upward. Easy-fit fabric graphic which conceals the structure beneath.

- Material :** Aluminium tubes, steel base
- Tubes diameter :** 30mm
- Assembly :** Push-button - tool-free
- Graphic attachment :** Zipped tension fabric graphic
- Graphic area :** Single or double-sided
- Mounting :** Free-standing with metal base (included)
- Bag :** Padded with compartments

600 mm	FORM-MON-600	📏 2380 (h) x 600 (w) x 300 (d) mm
800 mm	FORM-MON-800	📏 2380 (h) x 800 (w) x 300 (d) mm
900 mm	FORM-MON-900	📏 2380 (h) x 900 (w) x 300 (d) mm
1000 mm	FORM-MON-1000	📏 2380 (h) x 1000 (w) x 300 (d) mm
1200 mm	FORM-MON-1200	📏 2380 (h) x 1200 (w) x 300 (d) mm
1500 mm	FORM-MON-1500	📏 2380 (h) x 1500 (w) x 300 (d) mm

Accessorise it with optional literature or tablet holder

See all accessories on page 86



Zipped tension graphics for perfect fit

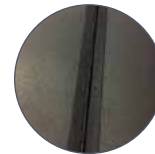

Folding hinged base (sizes 900mm and above)



Comes in a variety of widths from 600 - 1500mm



Stable structure



Stabilising feet



Double-sided frame with dramatic shape!



Tubes are connected by bungee cord and push buttons



Weighted base for additional stability

Formulate Wave



With an impressive height of 2.38m, stability is ensured with sleek steel feet. Made from Formulate aluminium tubing it's a real alternative to traditional roller banners.

- Material :** Aluminium tubes, steel stabilising feet
- Tubes diameter :** 30mm
- Assembly :** Push-button, Allen key
- Graphic attachment :** Zipped tension fabric graphic
- Graphic area :** Single or double-sided
- Mounting :** Free-standing with feet (included)
- Bag :** Padded

Wave	FORM-WAVE	📏 2380 (h) x 900 (w) x 608 (d) mm
------	-----------	-----------------------------------

Formulate Snake



Eye-catching shape tension banner made from strong and lightweight Formulate tubular system. Weighted horizontal and support poles for maximum stability.

- Material :** Aluminium tubes
- Tubes diameter :** 30mm
- Assembly :** Push-button - tool-free
- Graphic attachment :** Zipped tension fabric graphic
- Graphic area :** Single or double-sided
- Mounting :** Free-standing
- Bag :** Padded

Snake	FORM-SNA	📏 2380 (h) x 900 (w) x 700 (d) mm
-------	----------	-----------------------------------

Formulate Monolith LED



Available from Summer 2019



NEW 1 Available from Summer 2019

The new Formulate Monolith LED brings illumination to our ever popular Formulate range. With the ability to vary the height from 2m to 2.38m. This smart LED Lightbox is double-sided, easy to build and portable.

- Material :** Aluminium tubing
- Material :** 30mm
- Assembly :** Push-button - tool-free
- Graphic attachment :** Zipped tension fabric graphic
- Graphic area :** 360°
- Mounting :** Free-standing
- Bag :** Padded

Monolith LED	FORM-MON-LED-1100	Ⓞ 2000/2380 (h) x 1100 (w) x 350 (d) mm
--------------	-------------------	-----------------------------------------



Bungee push button lock



Tension fit zipped fabric graphics



LED strip lighting



LED Lightbox

Formulate Monolith Eco

NEW 1

For the budget conscious and a real alternative to roller banners offering uninterrupted double sided graphics.

- Material :** Aluminium tubes, powder coated steel feet
- Tubes diameter :** 25mm
- Assembly :** Push-button, Allen key
- Graphic attachment :** Zipped tension fabric graphic
- Graphic area :** Single or double-sided
- Mounting :** Free-standing with feet (included)
- Bag :** Carry bag

800 mm	FORM-MON-ECO-800	Ⓞ 2009 (h) x 800 (w) x 378 (d) mm
1000 mm	FORM-MON-ECO-1000	Ⓞ 2009 (h) x 1000 (w) x 378 (d) mm



Numbered tubes for easy assembly



Bungee tubes

Cost effective double-sided solution



Vortex



Lightweight and stable X-shaped banner. Graphic attached with eyelets, perfect for regular message updates. Suitable for substrates from 225-300 microns.

- Material :** Fibreglass, aluminium
- Graphic attachment :** Eyelets
- Graphic area :** Single-sided
- Mounting :** Free-standing
- Bag :** Carry bag with inner tube

Vortex	UB722-C	📏 1950 (h) x 855 (w) x 950 (d) mm
--------	---------	-----------------------------------



Eyelet bracket



Frame locking system



Reinforced feet for stability



Beijing Lite



Basic X-banner. Ultra-light frame. Very easy to assemble and compact once folded.

- Material :** Fibreglass
- Graphic attachment :** Eyelets
- Graphic area :** Single-sided
- Mounting :** Free-standing
- Bag :** Budget drawstring carry bag

800 x 2000 mm	WH358-8X20-01	📏 2000 (h) x 800 (w) x 720 (d) mm
---------------	---------------	-----------------------------------



Graphic attached by eyelets



Cost effective X-banner



Uno



Black tension 'L' shape banner with telescopic pole. Optimal stability. Banners are linkable to form larger seamless backwalls, using PVC panels or textile graphics.

- Material :** Aluminium pole and rail
- Graphic attachment :** Optional adhesive for PVC and SEG for textile
- Graphic area :** Single-sided
- Mounting :** Free-standing with foot (included)
- Bag :** Bag and graphics cardboard tube

Uno 800 mm	UB101C-800-B	⊗ 1600/2210 (h) x 800 (w) x 365 (d) mm
Uno 1000 mm	UB101C-1000-B	⊗ 1600/2210 (h) x 1000 (w) x 365 (d) mm

Accessories :

Linking Kit	UB106-003	⊗ N/A
Pole extension	UB101C-EP	⊗ up to 2900 mm
Wall Fabric Kit 2 m	UB101C-WKIT-2M	⊗ 1600/2210 (h) x 2000 (w) x 365 (d) mm
Wall Fabric Kit 3 m	UB101C-WKIT-3M	⊗ 1600/2210 (h) x 3000 (w) x 365 (d) mm
Wall Fabric Kit 4 m	UB101C-WKIT-4M	⊗ 1600/2210 (h) x 4000 (w) x 365 (d) mm
Wall Fabric Kit 5 m	UB101C-WKIT-5M	⊗ 1600/2210 (h) x 5000 (w) x 365 (d) mm

Link up to three PVC banners together, or five fabric banners as one impressive single graphic wall

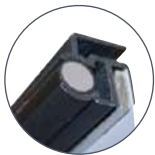

Linking banner rail



Modern foot design

Lightning



Popular 'L' banner combining stability with easy change graphics, simple assembly and lightweight to transport.

- Material :** Aluminium
- Graphic attachment :** Top and bottom snap rail
- Graphic area :** Single-sided
- Mounting :** Free-standing with stabilising foot
- Bag :** Carry bag with inner tube

Lightning 800 mm	UB195-C	⊗ 2070 (h) x 805 (w) x 510 (d) mm
------------------	---------	-----------------------------------

Economical solution for interchangeable graphics



Complete with carry bag with inner tube

Three part bungee pole





↪ Suitable for temporary outdoor use

↪ Graphic can be wider than the base



Optional CNC available for custom shaped graphics



Secure invisible fastening

Wedge



Durable and stable grey banner base. Designed to hold a variety of rigid graphics, supporting a range of sizes and thicknesses. Suitable for temporary outdoor use.

- Material :** Powder coated steel
- Graphic attachment :** Screwed to base
- Graphic area :** Single or double-sided
- Graphic option :** Rigid panel from 18-40mm thickness - optional extra 1500mm height max.
- Mounting :** Free-standing

Wedge 300 mm	UB102-300-S	☉, 85 (h) x 300 (w) x 360 (d) mm
Wedge 600 mm	UB102-600-S	☉, 85 (h) x 600 (w) x 360 (d) mm
Wedge 800 mm	UB102-800-S	☉, 85 (h) x 800 (w) x 360 (d) mm
Wedge 1000 mm	UB102-1000-S	☉, 85 (h) x 1000 (w) x 360 (d) mm



Flags

For both outdoor and indoor use, flags are an eye-catching option for displaying your message or giving directions.

There are a wide range of options available, from on-the-move street flags to our highly popular Zoom+ flags.

Flags are one of the most striking display options available.

Our flags can be made in a wide range of sizes, materials and finishes suitable for everyday environments such as tarmac, grass and for specialist environments including sand, snow and wall mounting.

No matter in which environment you wish to use our flags, we can provide a suitable construction and base that will serve your needs.

Flag shapes available

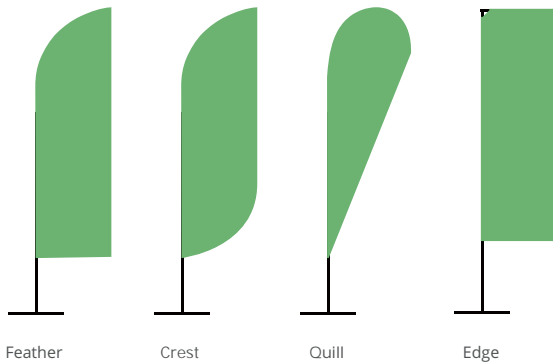

A Flag for all situations and locations



Free-standing



Wall mounted or post mounted



Backpack for mobility

Printing and finishing

Classic

Elastic pocket, single-sided print (classic)



Full Graphic

Printed pocket (full graphic)



Double-sided printing



Tips for taking care of your flag:

Flags are often exposed to the harshest conditions, even the highest quality materials and finishes will suffer if not treated with care. Here is our guide on how to take simple care of your flags:

- 1. Consider the positioning of your flag to minimise the effects of the environment.**
Air pollution can turn white areas grey, and too much UV light can cause fading and fabric deterioration.
- 2. Reducing the flying time will preserve the life of your flag.**
A flag will last between six and eight months when flown constantly, so taking down the flag when not in use will help it to last longer.
- 3. Take note of the climatic conditions.**
Flags should be taken down during poor weather conditions. Heavy rain and strong winds can increase the weight of the flag and put extra strain on the flagpole. Our flags are designed to withstand up to 18mph winds as standard.
- 4. Washing your flag.**
Flags can be machine washed with everyday soft detergents on a 30° wash. They should always be allowed to dry out completely before folding and storing.



Four large stackable water base for maximum stability

Comes with one pole (six part bungee pole and two end rods) two hooks and two elastic loops

Zoom+ Arch



The arch shaped flag is perfectly suited to identify entrances at events, particular sporting meets for registration areas, or race start / finish lines. For stability we recommend using two optional extra stackable bases per side.

- Material : GRP fibre glass pole - chrome steel end caps, plastic hook
- Graphic : Single-sided
- Graphic attachment : Pole pocket
- Wind resistance : Up to 32 km/h

Zoom+ Arch	ZOOM+ARCH	⊗ 2500/3000 (h) x 4000 (w) mm *
Stackable Water Base	UF-ZMSWB	⊗ 162.5 (h) x 642 (w) mm

* The height and width may vary depending on the size and shape of the graphic



Handle for ease of transportation



Flag attached by elastic and plastic hook



Base weighted once filled with water

Zoom+ Edge



Popular versatile lightweight flexible flag system with black finish all fibre poles. Ideal for all types of indoor or outdoor displays.

- Material :** Aluminium and GRP
- Pole :** Fibre
- Graphic :** Single or double-sided (only up to large size)
- Graphic attachment :** Printed pole pocket with stitched flag cord for tension
- Wind resistance :** Up to 18 mph / 29 km/h

Edge

Extra Large 5m	UF-ZME-EXLA	⊙ 5000 (h) x 750 (w) mm
Large 4m	UF-ZME-LA	⊙ 4000 (h) x 750 (w) mm
Medium 2.9m	UF-ZME-ME	⊙ 2900 (h) x 750 (w) mm
Small 2m	UF-ZME-SM	⊙ 2080 (h) x 750 (w) mm

Accessories :

Bag	AB-ZML-01
-----	-----------

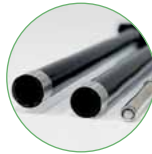

Zoom+ all fibre poles

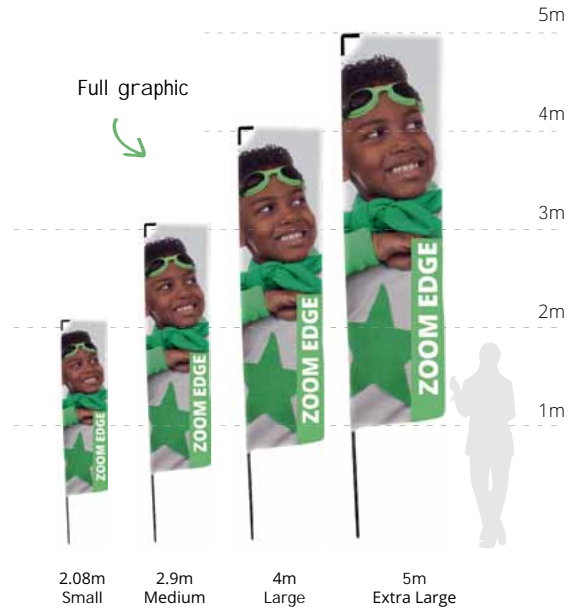

Zoom+ Crest / Feather / Quill



Popular versatile lightweight flexible flag system with black finish all fibre poles. Each flag can accommodate three different shaped graphics.

- Material :** Aluminium and GRP
- Pole :** Fibre
- Graphic :** Single or double-sided (only up to large size)
- Graphic attachment :** Elastic pole pocket with stitched flag cord for tension
- Wind resistance :** Up to 18 mph / 29 km/h

Crest / Feather

Extra Large 4.9m	UF-ZM-EXLA	⊙ 4900 (h) x 850 (w) mm
Large 4m	UF-ZM-LA	⊙ 4000 (h) x 800 (w) mm
Medium 3.2m	UF-ZM-ME	⊙ 3200 (h) x 600 (w) mm
Small 2.6m	UF-ZM-SM	⊙ 2600 (h) x 550 (w) mm

Quill

Extra Large 4.6m	UF-ZM-EXLA	⊙ 4600 (h) x 1200 (w) mm
Large 3.5m	UF-ZM-LA	⊙ 3500 (h) x 1100 (w) mm
Medium 2.8m	UF-ZM-ME	⊙ 2800 (h) x 900 (w) mm
Small 2.1m	UF-ZM-SM	⊙ 2600 (h) x 800 (w) mm

Accessories :

Bag	AB-ZML-01
-----	-----------



Adjustable hook fastening on all Zoom+ flag poles excluding Edge



Pole carry bag

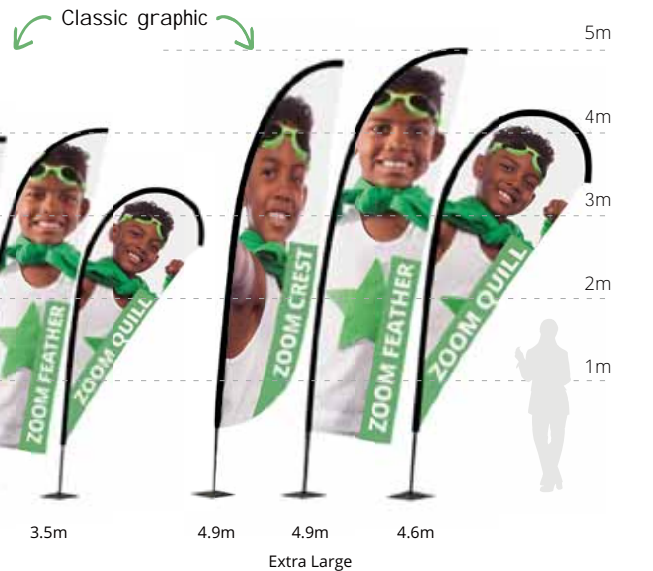
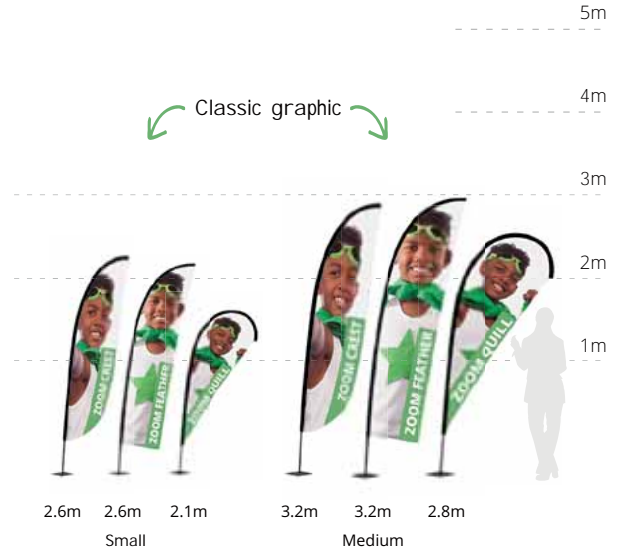

Recommended bases for Zoom+ Flags:

Bases			Zoom+ Flag shapes Edge / Quill /Crest / Feather				 Use with	 Use with
Base	Code	Weight / Capacity	Extra Large	Large	Medium	Small		
	Small Water Base WD102B-01	12 Litres			✓	✓		
	Large Water Base UF-ZMLWB	30 Litres	✓	✓	✓	✓		
	Stackable Water Base UF-ZMSWB	26 Litres	✓	✓	✓	✓		
	Small Square Base UF-ZMLSQ-01	7.26 kg			✓	✓	✓	✓
	Large Square Base UF-ZMLSQ-03	11.78 kg	✓	✓	✓	✓	✓	✓
	Small Cross Base UF-ZMSCB-01	N/A			✓	✓	✓	✓
	Large Cross Base UF-ZMLCB-01	N/A	✓	✓	✓	✓	✓	✓
	Budget Ground Spike UF-ZMBGS-01	N/A			✓	✓		
	Standard Ground Spike ZF-ZMGS-01	N/A	✓	✓	✓	✓		
	Plastic Ground Stake UF-ZMPSS-01	N/A	✓	✓	✓	✓		
	Concrete Base UF-ZMCEM	22kg	✓	✓	✓	✓	✓	✓
	Drive On Car Foot UF-ZMCFs-01	N/A	✓	✓	✓	✓		
	Wall Mount UF-ZMWMF-01	N/A			✓	✓		

Where flags are shown to be suitable for use with specific bases they have been tested in wind speeds of up to 18mph/29km/h

Formulate Lite



Lightweight yet strong and durable flag poles. Fast and easy to assemble with a choice of bases to suit most surfaces.

- Material :** 25mm diameter aluminium tubing
- Pole :** Push button connection
- Graphic :** Single-sided
- Graphic attachment :** Printed pole pocket with stitched flag cord for tension
- Wind resistance :** Up to 18 mph / 29 km/h



Hook fastening on Quill and Feather flags

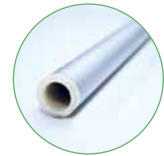

25mm Aluminium tubing

Three different shapes and a choice of sizes

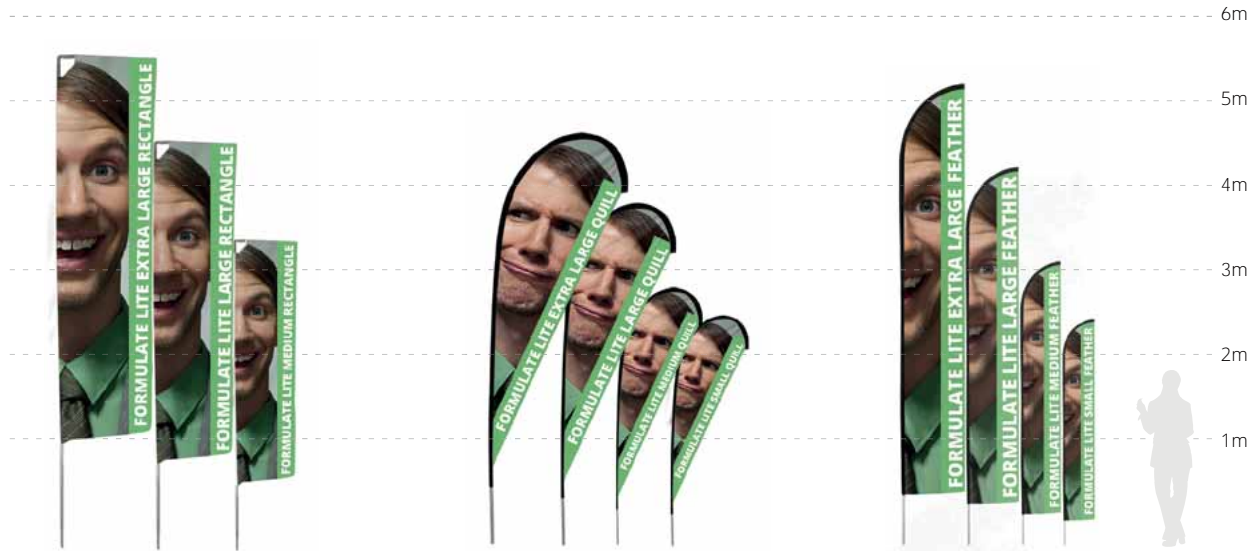

Rectangle Formulate Lite

Quill Formulate Lite

Feather Formulate Lite

Extra Large 5.5m	UF-FLR-XL	⊙	5510 (h) x 820 (w) mm
Large 4.5m	UF-FLR-L	⊙	4505 (h) x 820 (w) mm
Medium 3.5m	UF-FLR-M	⊙	3505 (h) x 720 (w) mm

Extra Large 4.5m	UF-FLQ-XL	⊙	4580 (h) x 930 (w) mm
Large 3.7m	UF-FLQ-L	⊙	3710 (h) x 836 (w) mm
Medium 2.8m	UF-FLQ-M	⊙	2860 (h) x 734 (w) mm
Small 2.3m	UF-FLQ-S	⊙	2300 (h) x 620 (w) mm

Extra Large 5.1m	UF-FLQ-XL	⊙	5135 (h) x 725 (w) mm
Large 4.1m	UF-FLQ-L	⊙	4195 (h) x 675 (w) mm
Medium 3.2m	UF-FLQ-M	⊙	3245 (h) x 625 (w) mm
Small 2.4m	UF-FLQ-S	⊙	2475 (h) x 575 (w) mm

Recommended bases for Formulate Lite Flags:

Codes	Bases													Please Note: † Requires the use of a weighted water ring or square and heavy duty pegs ‡ Requires the use of a weighted water ring or square
	Small Water Base	Large Water Base	Stackable Water Base	Small Square Base	Large Square Base	Small Cross Base	Large Cross Base	Budget Ground Spike	Standard Ground Spike	Plastic Ground Stake	Concrete Base	Drive On Car Foot		
	WD102B-01	UF-ZMLWB	UF-ZMSWB	UF-ZMLSQ-01	UF-ZMLSQ-03	UF-ZMSCB-01	UF-ZMLCB-01	UF-ZMBGS-01	ZF-ZMGS-01	UF-ZMPSS-01	UF-ZMCEM	UF-ZMCF5-01		
Formulate Lite Flags	Rectangle	Small	N/A	N/A	N/A	N/A	N/A	N/A	N/A	N/A	N/A	N/A	N/A	
		Medium	✓	✓	✓	✓ †	✓	✓ †	✓	✓	✓	✓	✓	
		Large		✓	✓	✓ †	✓		✓ †	✓	✓	✓	✓	Weighting Ring UB719-C
		Extra Large		✓	✓	✓ †	✓		✓ †	✓	✓	✓ †	✓	
	Feather	Small	✓	✓	✓	✓ †	✓	✓ †	✓	✓	✓	✓	✓	Weighting Square UF-ZMSWW01
		Medium	✓	✓	✓	✓ †	✓	✓ †	✓	✓	✓	✓	✓	
		Large		✓	✓	✓ †	✓		✓ †	✓	✓	✓	✓	
		Extra Large		✓	✓	✓ †	✓		✓ †	✓	✓	✓ †	✓	
	Quill	Small	✓	✓	✓	✓ †	✓	✓ †	✓	✓	✓	✓	✓	
		Medium	✓	✓	✓	✓ †	✓	✓ †	✓	✓	✓	✓	✓	
		Large		✓	✓	✓ †	✓		✓ †	✓	✓	✓	✓	1x Heavy Duty Peg FX620
		Extra Large		✓	✓	✓ †	✓		✓ †	✓	✓	✓ †	✓	

Shimmer



Economical telescopic flag with black water-fillable base included. Adjustable height up to 3m. Transport bags optional.

- Material : Aluminium pole, plastic base
- Pole : Telescopic (1540/2850 mm)
- Graphic : Single-sided or double-sided
- Graphic attachment : Printed pole pocket
- Base capacity : 14 litres
- Wind resistance : Up to 18 mph / 29 km/h

Shimmer	WD102-01	📏 1620/3000 (h) x 630 (w) x 385 (d) mm
---------	----------	----------------------------------------

Accessories :

Bag	AB120D	1580 (h) x 155 (Ø) mm
Bag with tube	AB120DM	1580 (h) x 155 (Ø) mm

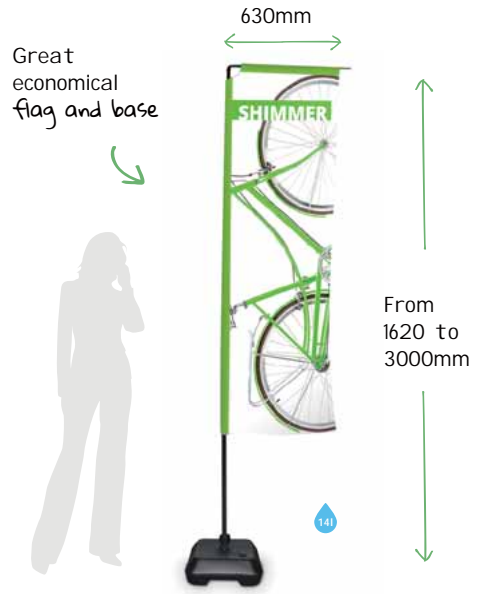

Wind Dancer



Telescopic flag, ideal for making an impact at outdoor events. Base can be filled with water or sand for optimum stability. Optional extra bags available for ease of transporting or storage.

- Material : Aluminium pole, plastic base
- Pole : Telescopic
- Graphic : Single-sided or double-sided
- Graphic attachment : Eyelets
- Base capacity : 66 litres
- Wind resistance : Up to 18 mph / 29 km/h

Wind Dancer	WD105	📏 2900/4170/5300 (h) x 1000 (w) x 1000 (d) mm
-------------	-------	-----------------------------------------------

Accessories :

Bag (pole and base)	AB105-C
---------------------	---------



Mistral



Perfect for promoting events outside, flags can be wall, pole or lamp post mounted and are made from weatherproof materials.

- Material : Aluminium castings and GRP tubes
- Tubes : Height adjustable
- Graphic : Single-sided or double-sided
- Graphic attachment : Pole pocket
- Wind resistance : Up to 40 km/h

Mistral	UB725-01	📏 Up to 2000 (h) x 890 (w) mm
---------	----------	-------------------------------

Maximum clamp pole diameter Ø 300mm



* Wall fixings not provided

NB: We strongly recommend wind slits for continuous use in all weather conditions. Wind slits reduce pressure on graphics.

Street Flag



The ideal advertising medium when on the move!
 Perfectly suited to promote events, highlight your presence at trade shows or to organise a group of people on excursions!
 This rugged and lightweight backpack can be used with four different flag shapes using the supplied poles.

- Material :** Reinforced nylon backpack, fibre poles
- Graphic :** Single-sided
- Graphic attachment :** Pole pocket or eyelets (X-banner)
- Graphic shapes :** Feather - Quill - Edge - X-banner

Street Flag	UF-ZMSTF-01	Ⓞ 540 (H) x 310 (B) x 80 (T) mm
-------------	-------------	---------------------------------



Reinforced pole fixing system



Zipped storage for poles and rods



Mesh storage pocket on the sides



Zipped flag storage compartment

One bag but four different flag shapes!





Outdoor

Giving your message the impact it deserves in outdoor locations requires specialist, high quality solutions.

Choose from our comprehensive range of banners and signage for displaying your brand in a wide variety of indoor or outdoor locations. Our range also includes tents, counters and backwalls, sign boards and barriers for pedestrian guidance, not to mention our choice of inflatables and parasols.



Choosing the right outdoor display product is important to ensure maximum branding impact and to attract your desired visitors and customers.

It is also critically important to make the right choice that will suit your environment; display area size, possible weather conditions, visitor numbers, mobility and repeat usage.

A taller display may make all the difference to the impact and performance of your branding.

Some Tips To Take Care Of Your Products

Outdoor products are designed for moderate outdoor usage during the daytime. But even high quality materials deteriorate if not treated with care and used in extreme weathers.

1. Choose your location carefully to minimise the effects of the environment.

Air pollution can turn white to grey, UV rays can also alter the colour of your visuals and cause deterioration on materials used.

2. Optimise exposure time.

By storing your Outdoor products between each use, their lifespan will be extended.

3. Consider climatic conditions.

All Outdoor products are not weather resistant in the same way. Heavy rain combined with high winds may increase the risk of deterioration of certain products. Follow the instructions given in the technical specification data sheets of each product provided.

Designed For All Occasions

- Outdoor Exhibitions
- Music Festivals
- Markets
- Sport Events
- Outside Sales Outlets
- Fairs
- and many others!

Our Outdoor Range



Roller and Tension Banners



Inflatable Displays



Pavement Signage



Café barriers



Parasols



Signage



Tents

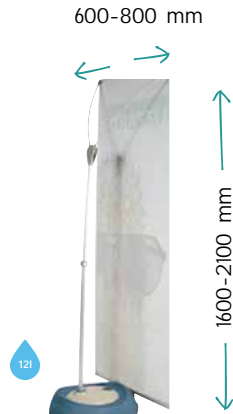

Large removable twin feet



Three part bungee pole



Twist and lock feet



Metal pegs

Blizzard



Easy to assemble on location, secured with large capacity base, graphic width and height is size adjustable to suit most applications.

Material :	Plastic and metal
Pole :	Adjustable in width and height
Graphic area :	Single-sided
Graphic attachment :	Eyelets
Base capacity :	12 litres
Wind resistance :	Up to 18mph / 28 km/h
Bag :	Non-padded (included) / padded (optional)

Blizzard	UB701	Ⓞ 1600/2100 (h) x 600/800 (w) x 540 (d) mm
----------	-------	--------------------------------------------

Accessories :

Blizzard padded bag	AB140-C
---------------------	---------

Thunder 2



The only outdoor roller banner with double sided graphics for maximum brand exposure and impact.

Material :	Plastic, aluminium and steel
Pole :	Three part bungee pole
Graphic area :	Double-sided
Graphic attachment :	Self-adhesive leader / top snap rail
Ground fixing :	4 pegs (included)
Wind resistance :	up to 7 mph / 11 km/h (unpegged) up to 24 mph / 39 km/h (if pegged)
Bag:	Padded

Thunder 2	UB185-850-01	Ⓞ 2200 (h) x 850 (w) x 385 (d) mm
-----------	--------------	-----------------------------------

Horizon



Maximum exposure display unit, perfect for outdoor large scale promotions. Securely weighted by twin water filled bases for total stability.

Material :	Aluminium, moulded grey plastic base
Pole :	Adjustable height (1500-2400 mm)
Graphic area :	Single or double-sided
Graphic attachment :	Eyelets
Base capacity :	28 litres per tank
Wind resistance :	8-12 mph / 12-19 km/h
Bag :	Non-padded (Optional)

Horizon	UB203	Ⓞ 1500/3000 (h) x 2500 (w) x 800 (d) mm
---------	-------	-----------------------------------------

Accessories :

Horizon pole bag	AB195A	Ⓞ 1730 (h) x 230 (w) x 190 (d) mm
Horizon base bag	AB195B	Ⓞ 900 (h) x 490 (w) x 370 (d) mm

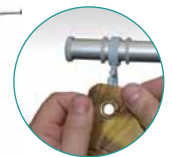

Graphic attached with eyelets



Telescopic pole with bungee for adjustable height

A-sign Board



Robust and sturdy Graphic area 'A' Poster frame with easy graphic front loading. Suitable for outdoor or indoor use.

- Material :** Aluminium, Galvanised steel, PVC sheet cover
- Graphic area :** Double-sided
- Graphic attachment :** Snap rail
- Wind resistance:** 13-18 mph / 20-28 km/h

A-sign Board A2	VF204-A2	Ⓞ 925 (h) x 465 (w) x 675 (d) mm
A-sign Board A1	VF204-C	Ⓞ 1060 (h) x 638 (w) x 825 (d) mm
A-sign Board A0	VF204-C-A0	Ⓞ 1440 (h) x 883 (w) x 835 (d) mm
A-sign Board B1	VF203	Ⓞ 1220 (h) x 848 (w) x 925 (d) mm
A-sign Board B0	VF203A	Ⓞ 1620 (h) x 1128 (w) x 1025 (d) mm



Complete with clear protective graphic cover



Whirlwind



A heavy-duty pavement swing sign with poster quick front loading. Easy to move thanks to its wheeled base and handle.

- Material :** Aluminium, steel, plastic base, PVC sheet cover
- Graphic area :** Double-sided
- Base capacity :** 25 l (A1) / 55 l (A0) / 49 l (B1)
- Graphic attachment :** Snap rail
- Wind resistance :** 13-18 mph / 20-28 km/h

Whirlwind A1	UB207	Ⓞ 1165 (h) x 780 (w) x 500 (d) mm
Whirlwind A0	UB207-A0	Ⓞ 1554 (h) x 1010 (w) x 625 (d) mm
Whirlwind B1	UB207-B1	Ⓞ 1350 (h) x 1000 (w) x 620 (d) mm



Wheeled compact moulded hollow base



Snap frame

Poster protected by PVC sheet



Available from Summer 2019



Swing

Available from Summer 2019

Simple, strong, economical and popular external swing sign with easy to change panel to keep your message fresh. No tools required.

Material : Rubber base, powder coated frame, aluminium panel
Graphic area : Double-sided
Graphic attachment : Eyelets and bolts
Base : 9kg
Wind resistance: 13-18 mph / 20-28 km/h

Swing	UB113	950 (h) x 600 (w) x 485 (d) mm
-------	-------	--------------------------------

Accessories :

Swing replacement panel	UB113-P	755 (h) x 500 (w) mm
-------------------------	---------	----------------------



Simply push the frame to locate into the base



Easy changing mechanism to re-brand your swing sign

Strong heavy duty rubber base

Shield

Functional rigid sign board with flexible aluminium panel securely bolted to the base. Safe graphic with rounded corners.

Material : Recycled rubber base, aluminium panel (1.2 mm)
Graphic area : Double-sided
Base : 8 kg
Graphic attachment : Bolts
Wind resistance: 13-18 mph / 20-28 km/h

Shield	UB108	800 (h) x 465 (w) x 450 (d) mm
--------	-------	--------------------------------

Accessories :

Shield replacement panel	UB108P	800 (h) x 410 (w) x 1.2 (d) mm
--------------------------	--------	--------------------------------



Print your message directly onto aluminium or mount self-adhesive vinyl



Choose between bottom spring clips or rail fixing options



Secure rail

Allows graphic movement thanks to bottom spring clips option

Deluxe Café

① TEX PVC

A modular portable café barrier system, chromed effect finish, to get a premium look and feel.

Material : Stainless steel
Graphic area : Single / Double-sided
Weight : 7.75 kg (Post and Base)
Graphic attachment : Looped top rail
 Looped bottom rail or spring clips

Graphic Rail 1000 mm	UB215-1000	⊘ 1140 (w) mm
Graphic Rail 1500 mm	UB215-1500	⊘ 1940 (w) mm
Graphic Rail 2000 mm	UB215-2000	⊘ 2440 (w) mm
Base	UB215B	⊘ 360 (Ø) mm
Post	UB215P	⊘ 960 (h) mm
Spring clips (pair)	UB215-SC	

Economy Café

① TEX PVC

A cost effective way of defining areas outside restaurants, bars and shopping centres. Heavyweight post and base. Black finish.

Material : Stainless steel
Graphic area : Single / Double-sided
Weight : 7.75 kg (Post and Base)
Graphic attachment : Looped top rail
 Looped bottom rail or spring clips

Graphic Rail 1000 mm	UB214-1000	⊘ 1140 (w) mm
Graphic Rail 1500 mm	UB214-1500	⊘ 1940 (w) mm
Graphic Rail 2000 mm	UB214-2000	⊘ 2440 (w) mm
Base	UB214B	⊘ 360 (Ø) mm
Post	UB214P	⊘ 960 (h) mm
Spring clips (pair)	UB214-SC	



An easy and simple way to define areas while advertising at the same time

Monsoon

The Monsoon is a large format Graphic outdoor 'A' frame banner, made from lightweight aluminium, ideal for use with PVC eyelet banners.

This trusted best selling banner is also available in wall mounted format, suitable for indoor or outdoor use. Easy to fit graphic can be changed regularly to suit your needs.

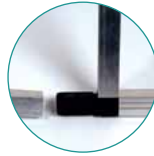

Push-fit joints



Wall mounted bracket



Graphic attached with eyelets



Metal hinges

Wall Monsoon



Wall mounted sign solution for pop-up shops and temporary signage. Graphic is secured with adjustable looped bungee cords.

Material : Aluminium tubes (25 mm), plastic connectors

Graphic area : Single-sided

Graphic attachment : Eyelets and looped bungee cords

Wall Monsoon 1250 mm	UB712-C	Ⓞ 1250 (h) x 1250 (w) x 130 (d) mm
Wall Monsoon 2000 mm	UB713-C	Ⓞ 1000 (h) x 2000 (w) x 130 (d) mm
Wall Monsoon 3000 mm	UB714-C	Ⓞ 1250 (h) x 3000 (w) x 130 (d) mm

Tool-free frame assembly



Custom made sizes available up to 5m in length

Monsoon



Easy to assemble on location thanks to its push-fit tubes system, this 'A' frame banner is ground pegged for extra-stability.

Material : Aluminium tubes (25 mm), plastic connectors

Graphic area : Single or double-sided

Graphic attachment : Eyelets and looped bungee cords

Wind resistance : 18-24 mph / 29-38 km/h

Monsoon 2500 mm	UB707-C	Ⓞ 1000 (h) x 2500 (w) x 640 (d) mm
Monsoon 3000 mm	UB711-C	Ⓞ 1250 (h) x 3000 (w) x 795 (d) mm



Supplied with ground pegs

Stowaway



Extremely portable and lightweight, this flexible banner pops out in seconds to form its oval shape. Tool-free assembly.

- Material :** Sprung steel pole
- Graphic area :** Double-sided
- Graphic attachment :** Elasticated pole pocket
- Ground fixing :** Four pegs (included)

Stowaway 1400 mm	UB736-03A	Ⓞ 700 (h) x 1420 (w) x 400/480 (d) mm
Stowaway 1700 mm	UB736-02A	Ⓞ 850 (h) x 1720 (w) x 400/480 (d) mm
Stowaway 2000 mm	UB736-01A	Ⓞ 1000 (h) x 2020 (w) x 400/480 (d) mm



Pack away into a small carry bag



Hook and loop stability straps

Instantaneous opening

Rainbow

Available from Spring 2019

Available from Spring 2019

Ultra compact promotional external display, lightweight and robust when pegged into soft ground. Flexible rods allow movement in the wind delivering maximum performance.

- Material :** Fibreglass pole, plastic end moulding
- Graphic area :** Double-sided
- Graphic attachment :** Elasticated pole pocket
- Ground fixing :** Four pegs (included)

Rainbow Large	RNB-03	Ⓞ 1219 (h) x 2438 (w) x 609 (d)
---------------	--------	---------------------------------

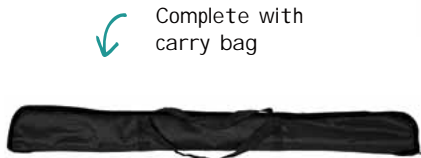

Complete with carry bag

Side arms attach together using hook and loop





Get noticed in a crowd with impressive displays!

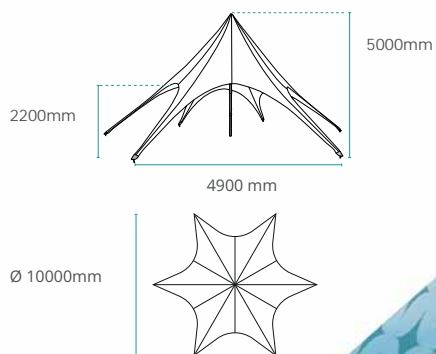

Eye-catching original shape

Canopy securely fastened with tent leg connectors and ultra heavy duty ground stakes

Available in two colours or custom full printed canopy



Star Tent



6 sided star tent supported with a telescopic pole providing a huge area for branding and plenty of shelter for your guests. Custom full printed canopy optional extra.

Material :	Aluminium
Graphic area :	Single-sided
Graphic attachment :	Pegged
Wind resistance :	up to 28 mph / 38km/h
Bag :	2 (included)



Frame and fixings come in bags



Supplied with six ground stakes



Crank handle



Base pole support



Wire rope setting-out guide

Star Tent Kit:	ST510-XAF	⊕ 5000 (h) x 10000 (w) x 10000 (d) mm
Canopy	ST510-CTW/B	Colours: White / Black

Zoom Tent



Lightweight aluminium tent frame with umbrella system. Folds and unfolds in minutes without tools. Dress it up with optional standard colour or custom full printed canopy, full and half walls.

- Material :** Aluminium frame, plastic joins
- Graphic area :** Double-sided (wall, half wall) / single-sided (canopy)
- Graphic colours :** White - Black - Blue - Red (standard) / Full Graphic (optional)
- Graphic attachment :** Hook and loop / Pocket (half wall)
- Wind resistance :** 13-18 mph / 20-28 km/h
- Ground fixing :** Pegs and ropes (included)
- Bag :** Wheeled Standard

Zoom Tent Frame 2x2	ZT22-XAF	Ⓞ 3160 (h) x 2000 (w) x 2000 (d) mm
Zoom Tent Frame 3x3	ZT33-XAF	Ⓞ 3160 (h) x 2920 (w) x 2920 (d) mm
Zoom Tent Frame 3x4.5	ZT345-XAF	Ⓞ 3160 (h) x 4300 (w) x 2920 (d) mm
Zoom Tent Frame 3x6	ZT36-XAF	Ⓞ 3160 (h) x 5800 (w) x 2920 (d) mm
Canopy	ZTXX-CTB/K/R/W	Colours : White / Black / Blue / Red
Full Wall	ZTXX-FWB/K/R/W	Colours : White / Black / Blue / Red
Half Wall	ZTXX-HWB/K/R/W	Colours : White / Black / Blue / Red

Accessories :

8kg weight	ZT-BASE
2-3m half wall mounting bar	ZT33-MTB
Zoom Tent connector	ZT-TJC
Zoom flag clamp	ZT-FCA



I deal for markets, sporting events and receptions

Available in four colours or custom full printed canopy



Add extra visibility by attaching a flag

Easy to collapse and pack away



shades and protects up to five people



Zoom Tent Eco



Cost effective steel tent frame. White powder coated finish. Folds completely into portable wheeled carry bag. Full printed canopy optional extra.

- Material :** Steel frame, plastic joins
- Graphic area :** Single-sided
- Graphic colours :** White (standard) / Full graphic (optional)
- Graphic attachment :** Hook and loop
- Wind resistance :** 13-18 mph / 20-28 km/h
- Ground fixing :** Pegs and ropes (included)
- Bag :** Wheeled standard

Zoom Tent Eco 3x3	FD33-SQF	Ⓞ 3315/3415/3510 (h) x 3310 (w) x 3310 (d) mm
Canopy	FD33-CTW	Colour: White



Collapsible frame



Bora Tent



Inflatable tent offers a fantastic 'canvas' for visual advertisements whilst providing shelter from the elements.
Trapped air technology: silent and free-standing once inflated.

- Material :** TPU, Polyester inner coat
- Graphic area :** Single-sided
- Graphic colours :** Blue - Dark grey - light grey (standard)
Full graphic (optional)
- Graphic attachment :** Zip system (standard) / hook and loop (full graphic)
- Ground fixing :** Pegs (optional)
- Wind resistance :** 19-24 mph / 29-38 km/h
- Bag :** Standard

Tent frame	UI00801	⊙, 2460 (h) x 3000 (w) x 3000 (d) mm
Canopy	UI00815-B/DG/LG	Colours : Blue / Dark Grey / Light Grey
Side Wall	UI00816-B/DG/LG	Colours : Blue / Dark Grey / Light Grey

Accessories :

Hand pump	CDX-INFTA-PM
Electric pump 400w	INFTA-PE4EU



Complete with carry bag



Inflatable structure



Bora Column



Get noticed in a crowd with the impressively tall 2.4m graphic of this inflatable column.
Trapped air technology: silent and free-standing once inflated.

- Material :** PVC column, plastic base
- Graphic area :** 360°
- Graphic attachment :** Hook and loop
- Ground fixing :** Four pegs (included)
- Wind resistance :** 15-24 mph / 24-38 km/h (if pegged)
- Bag :** Optional extra

Bora Column Kit	INFLCOL-220	⊙, 2390 (h) x 460 (Ø) mm
-----------------	-------------	--------------------------

Accessories :

Hand pump	CDX-INFTA-PM
Electric pump 400w	INFTA-PE4EU



New Version



Optional pumps



Plastic water base



Sunrise Square Parasol



Parasol combines marketing with functionality. Telescopic pole for ease of transportation and adjustable height. Automatic locking system once opened.

- Material : Powder coated steel
- Graphic area : Single-sided
- Opening : Clamp
- Wind resistance : 13-18 mph / 20-28 km/h (with optional cement base)

Sunrise Square Parasol with 20kg cement base	UU-SB	📏 2040-2740 (h) x 2000 (w) x 2000 (d) mm
----------------------------------------------	-------	------------------------------------------



Clamp opening and closing



Automatic locking



Ø 34/35 mm

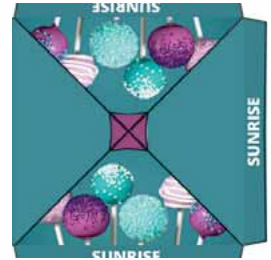

Pole carry bag

Perfect for summer advertising

Sunrise Circular Parasol



A great addition to any external event creating maximum impact delivering your brand message whilst sheltering you from the elements.

- Material : Powder coated steel
- Graphic area : Single-sided
- Opening : Handle
- Wind resistance : 13-18 mph / 20-28 km/h (with optional cement base)

Sunrise Circular Parasol with 20kg cement base	UU-CB	📏 2500 (h) x 2660 (Ø) mm
------------------------------------------------	-------	--------------------------



Winding handle



Safety chain and pin



Ø 38 mm



POS Signage

Whether you are welcoming visitors or pointing the way, choosing the right signage is an important way of capturing attention.

We have a wide range of professional signage systems to choose from, including indoor, wall mounted and poster frames, as well as free-standing and portable units for all your needs.



It is essential that Display Solutions match your interiors.

We have a comprehensive portfolio of Signage Solutions suitable for different settings such as: corporate office interiors, reception areas, public spaces as well as commercial, point of sale and retail environments.

Our versatile display solutions have a range of quality components for easy installation and a wide choice of fixing options for wall or ceiling suspension where required. They are also available in different finishes that perfectly match surroundings.



Before Choosing Your Display Solution, Please Consider the Following:

1. Do you need Free-Standing, Wall Mounted or Hanging Signage?
2. Does your display need to be printed or customised at all?
3. Does your signage need to be illuminated?
4. Do you plan to incorporate a device into the display like an LCD screen or iPad?

Our specialist Modular Solutions ranges, Twista and Strata, are made to order, with a wide range of fixing options and finishes to blend perfectly into your environment.

The Advantages of our Range



Contemporary Designs



Custom sizes and colours



Quick and easy installation



Simple graphic attachment

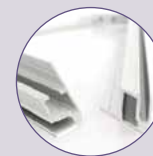

Lightweight and durable



Lockable for security



Twista Lite



Easy to use 'snap action' poster rail. Smart modern design. For use with a wide range of media up to 300 microns. Custom sizes available on request, up to 3100mm.

- Material :** Aluminium (rail), plastic (end caps, hooks)
- Colour:** Grey
- Mounting :** Wall / Ceiling
- Graphic area :** Single or Double-sided
- Graphic attachment :** Snap rail

500 mm Kit*	TWLHR-500	⊗, 31 (h) x 500 (w) x 12 (d) mm
600 mm Kit*	TWLHR-600	⊗, 31 (h) x 600 (w) x 12 (d) mm
800 mm Kit*	TWLHR-800	⊗, 31 (h) x 800 (w) x 12 (d) mm
850 mm Kit*	TWLHR-850	⊗, 31 (h) x 850 (w) x 12 (d) mm
900 mm Kit*	TWLHR-900	⊗, 31 (h) x 900 (w) x 12 (d) mm
1000 mm Kit*	TWLHR-1000	⊗, 31 (h) x 1000 (w) x 12 (d) mm
1200 mm Kit*	TWLHR-1200	⊗, 31 (h) x 1200 (w) x 12 (d) mm
1500 mm Kit*	TWLHR-1500	⊗, 31 (h) x 1500 (w) x 12 (d) mm
3000 mm Kit*	TWLHR-3000	⊗, 31 (h) x 3000 (w) x 12 (d) mm
2400 mm (rail only)	TWLHR-2400	
3100 mm (rail only)	TWLHR-3100	

*Kit includes two rails with end caps and two hooks

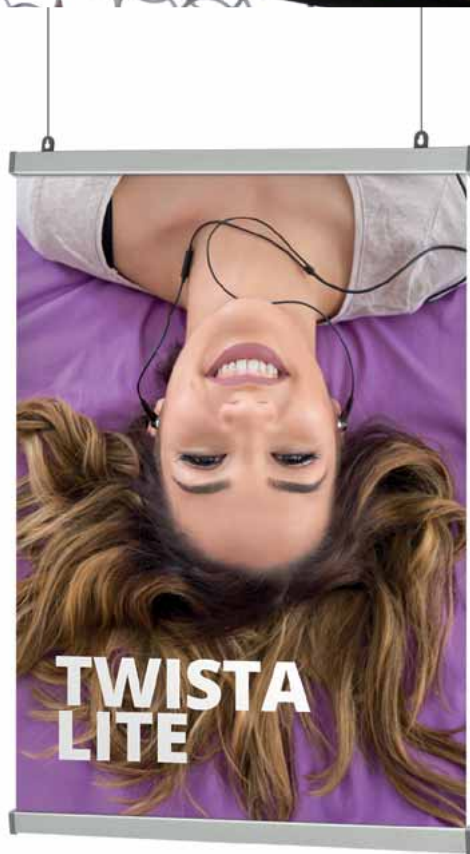

Very cost-effective snap-action solution

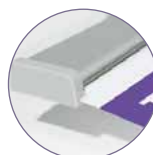

Rail end caps



Remove caps, open rail, insert graphics, clamp shut, replace caps

Strata System



Get a new perspective to your interior display. The Strata system is a versatile cable display solution with a choice of fixing options.

With a wide range of quality aluminium components for wall or ceiling suspension, Strata is available in silver satin or chrome finish for a stylish look.



Fastens from floor to ceiling ↘



Perfect to hold plexiglas panel ↗

Poster holder ↖



1 Strata Lite Stand-offs

- Suitable for 2-10mm thick substrates
- Choice of two diameters: 19mm and 12mm
- Quality aluminium components
- Available in satin or chrome finish
- Supplied in packs of four

Ø19 mm Satin	SP-SO1902
Ø19 mm Chrome	SP-SO1901
Ø12 mm Satin	SP-SO1202
Ø12 mm Chrome	SP-SO1201



2 Stand-offs

- Suitable for 2-20mm thick substrates depending on diameter used
- 16 mm diameter stand-offs are suitable for substrates between 2 and 8mm thick
- 25 mm diameter stand-offs are suitable for substrates between 5 and 20mm thick
- Choice of rail or screw fix options

Ø25 mm Large - Rail	PO101
Ø25 mm Large - Screw	PO102
Ø25 mm Medium- Rail	PO118
Ø25 mm Medium - Screw	PO117
Ø16 mm Small - Rail	PO104
Ø16 mm Small - Screw	PO105



3 Acrylic Poster Holder

- Acrylic poster holders have wings to take panel support fixings
- Available landscape or portrait

A1	AH411L/P
A2	AH412L/P
A3	AH413L/P
A4	AH414L/P
A5	AH415L/P



4 Double Panel Support

- Suitable for 4mm and 7mm thick substrates:
- 4mm - 10mm diam. x 20mm
- 7mm - 16mm diam. x 43mm with rotating feature for multi-angle fixing

PO122	⊙ 20 (h) x 10 (Ø) mm
PO121	⊙ 43 (h) x 16 (Ø) mm



5 Panel Supports

- PO113 suitable for 5mm thick substrates and A1, A2 and A3 poster holders
- PO112 suitable for 4mm thick substrates and A4/A5 poster holders

PO113	⊙ 15.5 (h) x 10 (Ø) mm
PO112	⊙ 20.5 (h) x 16 (Ø) mm



6 Rotating Edge Stand-offs

- Eliminate the need for an aperture in the substrate
- Suitable for 2-10mm thick substrates in rail or screw options
- Distance from wall or ceiling 18.5mm approx.

PO119	⊙ 34 (h) x 16 (Ø) mm
PO120	⊙ 34 (h) x 25 (Ø) mm



7 Compact Variable Wall Plate

- 180° variable fixing
- 360° free moving or lockable
- Suitable for fixing to walls or ceilings

PO106	⊙ 25 (h) x 16 (Ø) mm
-------	----------------------



8 Compact Variable Cable Fixing

- 180° variable fixing
- Choice of rail fix or screw fix options
- Cannot be used with PO110 cable kit

PO107 (Rail)	⊙ 25 (h) x 16 (Ø) mm
PO108 (Screw)	⊙ 25 (h) x 16 (Ø) mm



9 Aluminium Rail Screw Fixing

- Fix to ceiling or walls - cable fixings slot in and screw in to place
- Custom sizes available
- Complete with moulded end caps

Rail 1 m	PR102
Rail 2 m	PR101



10 Adjustable Fixing Cable

- Supplied with rail fixings
- Can be fixed wall-to-wall, floor to ceiling, direct to wall - extra components required

PO109	⊙ 4000 (w) x 1,5 (Ø) mm
-------	-------------------------



11 Floor to Ceiling Fixing Cable

- Adjustable cable kit, supplied with screw
- Not suitable for compact variable fixings

PO110	⊙ 4000 (h) x 1,5 (Ø) mm
-------	-------------------------



12 Insert for Screw Fixing

- Suitable for PO109 Strata Cable Kits and Stand-off components

Insert Screw fixing	PO116
---------------------	-------



13 Insert for Rail Fixing

- Suitable for PO109 Strata Cable Kits and Stand-off components

Insert Rail Fixing	PO115
--------------------	-------

Arty



Available Spring 2019

This versatile picture frame offers two alternative graphic options, to create a seamless canvas style image simply wrap around or opt for the stylish black frame with SEG graphic option.

- Material : Aluminium
- Profile depth : 22mm
- Profile colour : Black
- Assembly: Push-fit connector
- Graphic attachment : SEG 3 mm / Corner fixing clips
- Graphic area: Single-sided
- Mounting: Wall

Arty A3	AWF-A3	📏 420 (h) x 297 (w) x 22 (d) mm
Arty A2	AWF-A2	📏 594 (h) x 420 (w) x 22 (d) mm
Arty A1	AWF-A1	📏 841 (h) x 594 (w) x 22 (d) mm
Arty A0	AWF-A0	📏 1189 (h) x 841 (w) x 22 (d) mm

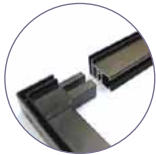

Tool-free assembly



Fabric graphic with silicone edge gasket (SEG)



Tension graphic fitting option



Corner tension bracket for easy wall mounting solution

NEW Available Spring 2019

Optional SEG graphic fitting with visible extrusion



Vector Quick Fix



Lightweight and extremely low profile to create a custom frame for decoration or retail applications. Extrusion can be cut to fit in a bag for easy transportation.

- Material : Anodised aluminium
- Profile depth : 20mm
- Profile colour : Silver
- Assembly : Screw-in bracket
- Graphic attachment : SEG 3mm
- Graphic area : Single-sided
- Mounting : Wall / connect to a shell scheme with bracket fixing (optional)

Vector Quick Fix - wall mounted	VWQF-CUSTOM	📏 Custom size
---------------------------------	-------------	---------------



Fabric graphic with silicone edge gasket (SEG)



Assembly with screw-in brackets

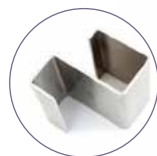

Optional mounting bracket LN134 for shell scheme fixing

Mounts easily straight onto walls by self drilling





Ø 1000mm

Ø 700mm



Perfect for interior decoration



Ø 400mm

Complete with wall fixings



Vector Slim Circular



Create a smooth and sleek effect with this lightweight rounded wall frame. With a range of standard sizes and custom options available, you don't ever have to be square again.

Material :	Aluminium
Profile depth :	20mm
Profile colour :	Silver
Assembly :	Screw-in connector
Graphic attachment :	SEG 3mm
Graphic area :	Single-sided
Mounting :	Wall

Ø 400 mm	WWFC-400	⊘ 400 (Ø) mm
Ø 700 mm	WWFC-700	⊘ 700 (Ø) mm
Ø 1000 mm	WWFC-1000	⊘ 1000 (Ø) mm
Custom size	WWFC-CUSTOM	⊘ Custom



Easy assembly



Fabric graphic with silicone edge gasket (SEG)



20mm aluminium profile

Ideal for interior decoration

Vector LED 30mm



Cost effective backlit LED frame, with ultra thin profile. Perfect for small format displays, sleek design that creates an amazing visual impact bringing your brand to life.

- Material :** Aluminium
- Profile depth :** 30mm
- Profile colour :** Silver
- Assembly :** Screw-in bracket
- Graphic attachment :** SEG mm
- Graphic area :** Single-sided
- Mounting :** Wall

Vector LED 30 mm	VLB30-CUSTOM	Custom size
------------------	--------------	-------------



Linkable LED lighting system

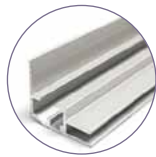

Aluminium profile



Screw-in bracket



consistent lighting across the graphic



Vector LED 75mm



Large format wall mounted edge lit lightbox, creating even light across a wide area to illuminate your chosen graphic helping you stand out from the crowd.

- Material :** Aluminium
- Profile depth :** 75mm
- Profile colours :** Silver
- Assembly :** Screw-in bracket
- Graphic attachment :** SEG 3mm
- Graphic area :** Single-sided
- Mounting :** Wall

Vector LED 75 mm	VLB75-CUSTOM	Custom sizes
Vector LED 75 mm	VLB75-2X1	2000 (h) x 1000 (w) x 75 (d) mm
Vector LED 75 mm	VLB75-2X2	2000 (h) x 2000 (w) x 75 (d) mm
Vector LED 75 mm	VLB75-2X3	2000 (h) x 3000 (w) x 75 (d) mm



360mm LED strip



Simple assembly with mitred profiles and corner brackets



Cabling system



Great for larger wall coverings



Reflecta Trappa

1 PVC

Free-standing lightbox or graphic pod. Easy-to-use 'snap-action' system for interchangeable graphics. Supports Linear accessories.

Material : Aluminium pole, MDF table top/base, acrylic sheet cover
Graphic area : Single or double-sided
Graphic attachment : Snap-action frame
Table top/Base Colours : Black / silver / white / beech

840 mm (Lightbox)	MR914T	⊗ 840 (h) x 570 (w) x 280 (d) mm
840 mm	MR103T	⊗ 840 (h) x 570 (w) x 280 (d) mm
1040 mm (Lightbox)	MR911T*	⊗ 1040 (h) x 1000 (w) x 400 (d) mm
1040 mm	MR101T	⊗ 1040 (h) x 1000 (w) x 400 (d) mm
1570 mm (Lightbox)	MR915T	⊗ 1570 (h) x 570 (w) x 280 (d) mm
1570 mm	MR104T	⊗ 1570 (h) x 570 (w) x 280 (d) mm
1840 mm (Lightbox)	MR912T*	⊗ 1840 (h) x 1000 (w) x 400 (d) mm
1840 mm	MR102T	⊗ 1840 (h) x 1000 (w) x 400 (d) mm

*Acrylic, foamex and protective acetate is not included



Snap rail



Clear protective acetate cover



Table top and base available in four colours :



Sleek elliptical shape

Teva*

1

Telescopic and wheeled multi-functional mobile LCD/LED/Plasma stand*. Black finish. Integrated cable management system inside pole uprights.

Material : Steel, plastic (shelf)
Screen sizes* : 37"-65" (45kg load max)
AV Shelf : One (4.5 kg load max)
Camera tray: One (4.5 kg load max)
Wheels : Four

Teva	LN250	⊗ 1030-1530 (h) x 850 (w) x 730 (d) mm
------	-------	----------------------------------------

*TV screen and Video/AV equipment are not included and not available to purchase



Smooth rolling braked castors

Height-adjustable camera tray and monitor for maximum visibility



Screen size : 37" - 65"



Comes with camera tray and AV accessories shelf



1030 - 1530 mm

1030 - 1530 mm

1030 - 1530 mm

Free-standing iPad Holder*



Durable and theft resistant free-standing iPad holder. For extra security the base can be bolted to the floor or stand.

Material : Steel
Locking : Security screws/Allen key (included)
Tablet positioning : Portrait or Landscape
Tablet size : iPad 2, 3, 4 and iPad Air
Ground fixing : Bolts (included)

Black	IPS-001-B	⊗ 1045/1060 (h) x 360 (Ø) mm
White	IPS-001-W	⊗ 1045/1060 (h) x 360 (Ø) mm



In white

Rotate to use in portrait or landscape format



Design iPad Holder*



Design and secure housing frame that can be mounted onto a counter, wall or a Linear post with 360° iPad holder option.

Material : Aluminium, steel
Locking : Security screws/Allen key (included)
Tablet positioning : Portrait or Landscape, or 360° with mount option
Tablet size : All iPad except Mini and Pro models*

Black Frame	IPAD-CHU-W	⊗ 310 (h) x 225 (w) x 20 (d) mm
Silver Frame	IPAD-CHU-S	⊗ 310 (h) x 225 (w) x 20 (d) mm
White Frame	IPAD-CHU-B	⊗ 310 (h) x 225 (w) x 20 (d) mm
Black Frame + 360° mount	IPAD-SH-360W	⊗ 310 (h) x 225 (w) x 95 (d) mm
Silver Frame + 360° mount	IPAD-SH-360S	⊗ 310 (h) x 225 (w) x 95 (d) mm
White Frame + 360° mount	IPAD-SH-360B	⊗ 310 (h) x 225 (w) x 95 (d) mm

Sleek rounded corners



Frame with optional 360° mount



Can be mounted onto a counter, wall or a post

Formulate Universal Tablet Holder*



Lightweight free-standing tablet holder that can host universal tablet sizes thanks to its adjustable bracket. Modern and design shape. Optional literature holders.

Material :	Ø30mm aluminium bungee tubes, metal base, plastic connector
Locking :	Security screws/Allen key (included)
Tablet positioning :	Portrait or Landscape
Tablet size :	8.6"-13.7" (22.2-35.5cm) diagonal / 0.9cm thickness
Graphic option :	Double-sided fabric graphic (optional)
Ground fixing :	5.2kg Weighted base (included)

Frame	FORM-UNI-TAB-01	📏 1230 (h) x 350 (w) x 640 (d) mm
Black literature holder rack (use two max) optional extra	FORM-UNI-TAB-LIT-B	📏 155 (h) x 350 (w) x 75 (d) mm



Internal reinforcement

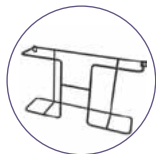

Black literature holder rack (optional)



Complete with padded carry bag



Adjustable tablet holder bracket



Optional Literature holders can display portrait or landscape brochures.



5.2kg Weighted base plate included for stability

Telescopic Universal Tablet Holder*



Versatile telescopic tablet stand. Security screws and lock make the unit both durable and theft resistant. For extra stability, the base can be bolted to the floor.

Material :	Anodised aluminium pole, steel black base
Locking :	Security screws/Allen key (included)
Tablet positioning :	Portrait or Landscape
Tablet size :	Maximum: 275 (w) x 195 (h) x 10 (d) mm Minimum: 135 (w) x 275(h) x 10 (d) mm
Ground fixing :	Bolt (included)

Telescopic Universal Tablet holder	IPS-003-B	📏 Portrait: 795-1225 (h) x 440 (w) x 335 (d) mm Landscape: 735-1175 (h) x 440 (w) x 335 (d) mm
------------------------------------	-----------	---------------------------------------------------------------------------------------------------



Can be used portrait or landscape



Adjustable height



Lockable

Sentry



'Snap-action' free-standing poster frame that is ideally suited to information display. Head rotates for either portrait or landscape format literature.

Material :	25mm aluminium profile, clear PVC protection sheet
Colour:	Anodised silver finish, chromed corners
Mounting :	Free-standing
Frame positioning:	Portrait or Landscape
Graphic option:	Suitable for substrates up to 420 microns
Graphic attachment :	Snap rail

Sentry A3	SL103	📏 1075 (h) x 245 (w) x 326 (d) mm
Sentry A4	SL104	📏 1005 (h) x 245 (w) x 326 (d) mm



Trappa Frame



Very easy-to-use 'snap-action' poster frame enables messages to be updated quickly and often. Mitred corner.

Material :	25mm aluminium profile, clear PVC protection sheet
Colour:	Anodised silver finish
Mounting:	Wall*
Frame positioning:	Portrait or Landscape
Graphic option:	Suitable for substrates up to 420 microns
Graphic attachment :	Snap rail

Trappa A4	AT401-C	📏 328 (h) x 241 (w) x 13 (d) mm
Trappa A3	AT402-C	📏 451 (h) x 328 (w) x 13 (d) mm
Trappa A2	AT403-C	📏 625 (h) x 451 (w) x 13 (d) mm
Trappa A1	AT404-C	📏 872 (h) x 625 (w) x 13 (d) mm
Trappa A0	AT405-C	📏 1220 (h) x 872 (w) x 13 (d) mm

* screws not supplied



Basics Leader



Basics range for retractable barrier system, ideal for use in retail outlets and airports to define queue guidance.

Material :	Steel, aluminium, plastic
Post and base colours:	Black / silver
Belt colours :	Red / grey / black

Basics Leader Kit (Black post - red/grey/black belt)	SP-800B-R/G/B	📏 910 (h) x 2000 (w) x 350 (d) mm
Basics Leader Kit (Silver post - red/grey/black belt)	SP-800S-R/G/B	📏 910 (h) x 2000 (w) x 350 (d) mm



Spiral Plinth



Portable collapsible counter that assembles in seconds without the need for tools thanks to its twist and lock system. Add interactivity with optional iPad holder.

Material :	Steel, plastic, wood
Assembly :	Self-locking system
Shelves :	Two (max load 4kg)
Graphic option :	Acetate panels (included) / 1-2mm PVC panels (optional)
Graphic attachment:	Mag tape (included)
Bag :	Wheeled padded bag

Spiral Plinth	UB710	📏 1070 (h) x 580 (Ø) mm
---------------	-------	-------------------------

Accessories :

iPad Holder*	UB710-IPDM-B/S/W	Colours: Black / Silver / White
--------------	------------------	---------------------------------

*Please note all tablets and iPads are not included and not available to purchase



iPad holder* optional extra

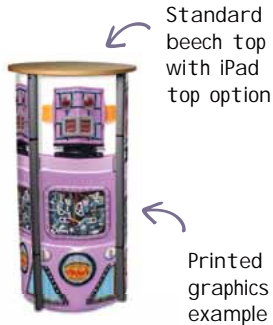

Standard beech top with iPad top option

Printed graphics example



Show with iPad option



Fully collapsible

Spiral Display Tower



Fully collapsible tower that locks automatically once in place. Ideal for showcasing your products on shelves. Custom branding by replacing the acetate panels with your own graphics.

Material :	Steel, plastic
Assembly :	Self-locking system
Shelves :	Four (max load 4kg)
Lighting :	20 Watt - 12 Volts
Graphic option :	Acetate panels (included) / 1-2mm PVC panels (optional)
Graphic attachment:	Mag tape (included)
Bag :	Wheeled padded bag

Spiral Display Tower	UB710-002	📏 2070 (h) x 560 (Ø) mm
----------------------	-----------	-------------------------



Top mounted down-lighter



Twist and lock assembly system



Comes with wheeled padded bag

Formulate Oval Table



Lightweight tubular aluminium structure that's easy to assemble and easy to dress with optional printed washable zipped tension fabric graphic. Ideal for maximising brand messages.

Material : Ø30 mm aluminium tubes, MDF top and base
Graphic area : 360°
Assembly: Push-fit buttons, screw

Oval Table	FMLT-TS-06	950 (h) x 1600 (w) x 520 (d) mm
------------	------------	---------------------------------

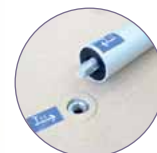
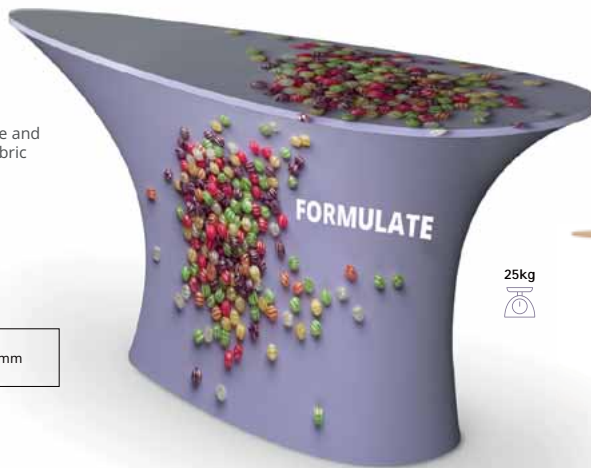

Tool-free assembly



Fold-able top and base

Full printed Graphic option



Numbered frame parts



Formulate Round Table



Popular table shape for reception. Welded base for extra stability. Display your message at 360° angle with optional washable tension fabric graphic.

Material : Ø30 mm aluminium tubes, MDF top
Graphic area : 360°
Assembly: Push-fit buttons, screw

Round Table	FMLT-TS-01A	1000 (h) x 600 (Ø) mm
-------------	-------------	-----------------------

Gala



Portable strong trestle folding table. Cover with an optional printed table cloth for a professional look, choose from traditional or fitted format.

Material : Polypropylene, metal
Graphic area : 360°
Assembly: Locking mechanism

Gala Table 1.8m	FT-6	Open : 745 (h) x 1835 (w) x 750 (d) mm Closed : 80 (h) x 885 (w) x 750 (d) mm
Gala Table 2.4m	FT-8	Open : 730 (h) x 2403 (w) x 753 (d) mm Closed : 90 (h) x 1215 (w) x 753 (d) mm



Folds in half for easy transportation

Different table cloths available



Carry handle



Centre locking mechanism

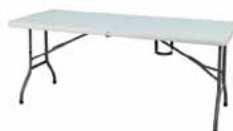

Available from Spring 2019

Counters

Designed for a wide variety of uses, our portable counters cater for almost any situation or occasion and are an ideal way to welcome your guests.

We have designed a comprehensive range of items in many shapes and sizes, most of which can support graphics that project your brand.



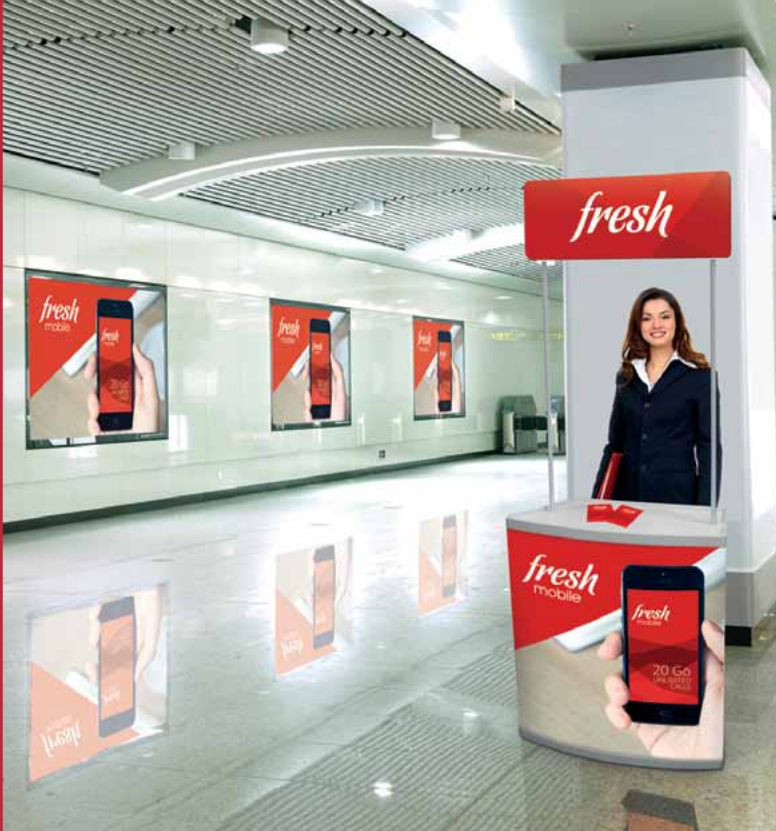

We provide counters for all budgets and requirements.

Our counters can serve as display surfaces, lecterns, data pods, workstations, display towers, columns and plinths and the variations of what you can do with them is infinite.

You can also increase your impact by adding height and visibility with a header kit or flag. Our Counters are simple and quick to build with tool-less construction, they are made in-house and can be made to order if customisation is required.

Before choosing your counter, please consider the following:

1. How many times will it be used? Occasionally or regularly?
2. Do you need to transport it? And how often?
3. Will you need storage for catalogues for example?
4. Do you need to host visitors or give a lecture?

Standard solutions...



Counter



Vector



Physique



Linear



Formulate

... Customisable solutions



Custom sizes



Tabletop colour



Graphics



Lockable door



Cable management



Built in iPad*

Pop-up Counta



A convenient lightweight pop-up counter that offers a substantial area to welcome your guests yet packs down for easy transportation in a reinforced D-shaped wheeled trolley case.

Material :	Aluminium, plastic, MDF
Assembly :	Self-locking magnetic
Collapsible :	Yes
Counter top :	Fold-able - Beech colour
Graphic attachment :	Magnetic hangers, bars and tape (included) Suitable for 440 microns min. substrate (optional extra)
Shelves :	Four
Bag :	1 Wheeled trolley case

2x1	PUC21C-C	📏 985 (h) x 865 (w) x 400 (d) mm
2x2	PUC22C-C	📏 985 (h) x 1290 (w) x 465 (d) mm



Magnetic fixing



Wheeled trolley case



Quick and easy to assemble



Hop-up Counta



Durable lightweight hop-up counter, quick and easy to assemble with a single wrap around fabric graphic which stays on when collapsed and packed away. Perfect to welcome your guests.

Material :	Aluminium, plastic, MDF tabletop, polycarbonate shelf
Assembly :	Plastic locking arms
Collapsible :	Yes
Counter top :	Beech
Graphic attachment :	Hook and loop
Shelves :	One
Bag :	One wheeled carry bag

Hop-up	HU301-001-C	📏 1020 (h) x 1060 (w) x 360 (d) mm
--------	-------------	------------------------------------



Plastic locking arm



Wheeled carry bag

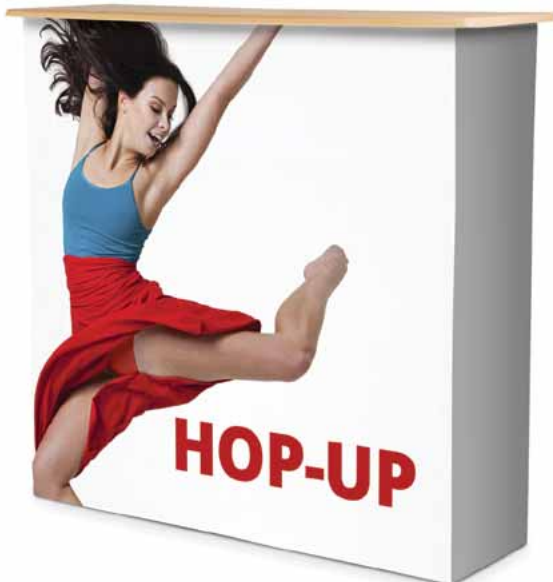

Fabric graphic folds with the counter

Shelf included



SEG Counter



Collapsible display counter with self-locking magnetic assembly. Optional fabric Silicone Edged Graphic (SEG) fits easily into the channel for a perfect tension.

Material :	Aluminium, plastic, MDF tabletop/base
Assembly :	Self-locking magnetic
Collapsible :	Yes
Counter top :	Beech / black / silver / white
Graphic attachment :	Silicone Edged Gasket (SEG)
Shelves :	Two
Bag :	One carry bag

SEG	PUC21C-SEG	📏 990 (h) x 840 (w) x 365 (d) mm
-----	------------	----------------------------------



Attach graphic into SEG channel



Carry bag

Open back for ease of access to shelves



Available from Spring 2019

Embrace+ Counter



Double-sided collapsible counter with aluminium frame for dressing with visual textile. Backlit graphics boost your brand messaging.

Material :	Aluminium, plastic, metal locking arms, MDF tabletop
Assembly :	Plastic frame
Collapsible :	Yes
Counter top :	White
Graphic attachment :	Silicone Edged Gasket (SEG)
Accessories :	LED lighting (included)
Bag :	Bag included

Embrace LED Counter	EMB-PL-CNTR-LED	📏 1022 (h) x 1000 (w) x 375 (d) mm
---------------------	-----------------	------------------------------------



Attach graphic into SEG channel



Internal LED lighting

Formulate Magnetic Counter



 PATENT PENDING

 NEW



New patent-pending magnetic counter - increase your counter size by simply connecting multiple counters using magnetic elements. Maximum table top load 40kg, maximum shelf load 20kg.

- Material : Ø 30mm Aluminium tubes, MDF tabletop/shelf
- Assembly : Push-fit button
- Collapsible : No
- Counter top : Black
- Graphic attachment : Zip system
- Shelves : One - optional extra
- Bag : One padded carry bag, internal flap

Magnetic counter	FORM-MOD-CNTR-01	 1015 (h) x 800 (w) x 600 (d) mm
Shelf	FORM-MOD-CNTR-02	 9 (h) x 770 (w) x 571 (d) mm



Counters join by magnets only



Black laminate MDF tabletop included



Internal shelf optional extra

from this

to this - just using magnets - no tools required!



Choose to have the tabletop visible or hidden

Full graphic option



Join multiple units together to create a larger counter, reception desk or bar area!

Vector Counter Straight



Robust counter built from modular Vector extrusions. Rounded corners for a seamless tension graphic. Available in custom sizes. Manufactured to order.

Material :	Aluminium, MDF tabletop/shelf
Assembly :	Cam locks and Allen key
Collapsible :	No
Counter top :	Beech / black / silver / white
Graphic attachment :	Silicone Edged Gasket (SEG)
Shelves :	One
Bag :	Two carry bags - optional extra

Vector	VSCB	📏 1015 (h) x 1040 (w) x 545 (d) mm
--------	------	------------------------------------

Accessories :

Tube bag (counter)	AB120AM
Carry bag (shelf and tabletop)	AB914



Attach graphic into SEG frame channel



Optional carry bag

Four colours available:



Available in custom sizes



Vector Counter Curved



Strong and stylish finish counter built-in from modular Vector profiles system. Available in custom sizes. Manufactured to order.

Material :	Aluminium, MDF tabletop/shelf
Assembly :	Push-fit button
Collapsible :	No
Counter top :	Beech / black / silver / white
Graphic attachment :	Silicone Edged Gasket (SEG)
Shelves :	One
Bag :	Two carry bags - optional extra

Vector curved	VCCB	📏 1015 (h) x 1340 (w) x 540 (d) mm
---------------	------	------------------------------------

Accessories :

Carry bag (shelf and tabletop)	AB916
Carry bag kit (counter)	AB120AC-KIT



Rounded corners



Carry bags

Stylish curved counter



Manufactured to order



Four colours available:



Linear Straight Counter



Solid and durable counter made from Linear posts, yet flat-pack for easy transportation. Recommended with 3-5mm thick PVC foamed board graphics (optional extra).

Material :	Anodised aluminium, MDF tabletop/base
Assembly :	Twist and lock system, tool-free
Collapsible :	No
Tabletop/Base :	Beech / black / silver / white
Graphic attachment :	Magnetic (for 1mm substrate - optional extra) Infills panels (for 3-5mm substrate - optional extra)
Shelves :	One - optional extra
Bag :	One carry bag - optional extra

1000 mm (w)	LK029-001	📏 1010 (h) x 1000 (w) x 500 (d) mm
2000 mm (w)	LK029-002	📏 1010 (h) x 2000 (w) x 500 (d) mm

Accessories :

Linear counter bag 1000 mm	AB112A
Linear counter bag 2000 mm	AB222
Internal shelf	PK8-S15



Optional steel literature holder

Linear Lite Counter



Straight Lite Counter made from solid anodised aluminium for 3-5mm thick PVC foamed board graphics (optional extra).

Material :	Anodised aluminium, MDF tabletop/base
Assembly :	Twist and lock system, tool-free
Collapsible :	No
Tabletop/Base :	Beech / black / silver / white
Graphic attachment :	Magnetic (for 1mm substrate - optional extra) Infills panels (for 3-5mm substrate - optional extra)
Shelves :	One - optional extra
Bag :	One carry bag - optional extra

Linear Lite	LK038	📏 1040 (h) x 915 (w) x 405 (d) mm
-------------	-------	-----------------------------------

Accessories :

Carry bag	AB112A
Case	AC311
Internal shelf	PK8-S15
A4 Steel Literature Holder	LN112-004
A5 Steel Literature Holder	LN112-005

Linear Curved Counter



Stylish 30° or 45° curved counters made from Linear profiles. Available in Pro version with top shelf option, or in standard one. Recommended with 2mm thick PVC foamed board graphics (optional extra).

Material :	Anodised aluminium, MDF tabletop/base
Assembly :	Twist and lock system, tool-free
Collapsible :	No
Tabletop/Base :	Beech / black / silver / white
Graphic attachment :	Magnetic (for 1mm substrate - optional extra) Infills panels (for 3-5mm substrate - optional extra)
Shelves :	One - optional extra
Bag :	One carry bag - optional extra

Standard 30°	LK028-001	📏 1010 (h) x 1025 (w) x 546 (d) mm
Standard 45°	LK028-003	📏 1010 (h) x 1515 (w) x 607 (d) mm
Pro 30°	LK028-002	📏 1010 (h) x 1025 (w) x 546 (d) mm
Pro 45°	LK028-004	📏 1010 (h) x 1515 (w) x 607 (d) mm

Accessories :

Carry bag for 30°	AB112A
Carry bag for 45°	AB221
Internal shelf	PK8-S15

Pro version with acrylic shelf and stand-offs



Standard version



Lecturn Linear Column



Attractive modern styled lecturn column with feature acrylic table top shelf mounted on stand-offs. Ideal for conference presentations or meeting rooms.

Material : Anodised aluminium, MDF tabletop/base, acrylic shelves
Assembly : Allen Key
Collapsible : No
Tabletop/Base : Beech / black / silver / white
Graphic attachment : Post channel infills (for 1mm PVC graphics - optional extra)
Shelves : One internal - One top shelf

Lecturn Linear	LNC-LEFO	📏 1015 (h) x 640 (w) x 325 (d) mm
----------------	----------	-----------------------------------

Stylish acrylic shelf with stand-offs

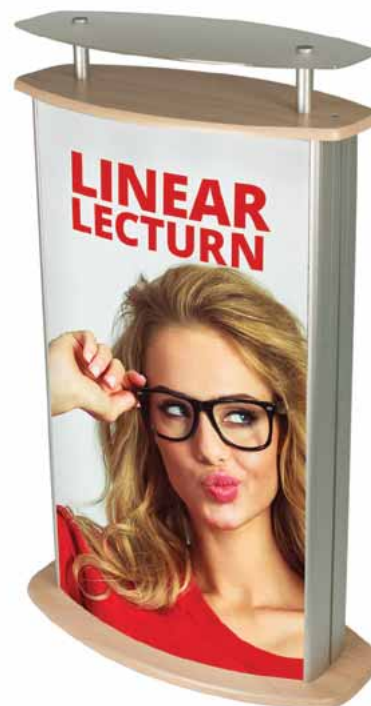

Internal shelf included

Linear Column



Versatile and elegant column available in a standard or slim variant with the option to use as a lightbox.

Material : Anodised aluminium, MDF tabletop/base
Assembly : Allen Key
Collapsible : No
Tabletop/Base : Beech / black / silver / white
Graphic attachment : Post channel infills (for 1mm PVC graphics - optional extra)

Standard	LNC-STFO	📏 1010 (h) x 640 (w) x 325 (d) mm
Standard LED*	LNC-STLB	📏 1010 (h) x 640 (w) x 325 (d) mm
Slim	LNC-SLFO	📏 1010 (h) x 380 (w) x 245 (d) mm
Slim LED*	LNC-SLLB	📏 1010 (h) x 380 (w) x 245 (d) mm

* Comes with acrylic panels, optional printing available.

Four colours available:



Both columns are available in standard or LED versions!



Gear Edge Counter



Aluminium counter ideal for complimenting exhibition panel displays. Graphic panels are simple to change along with your promotion or message.

Material :	Aluminium, MDF tabletop/base
Assembly :	Fold-able (standard), Allen key if graphics change
Collapsible :	No
Counter top :	Beech / black / silver / white
Graphic attachment :	Infill panels (for 3-5mm substrate - optional extra) Hook and loop if fixing onto fabric panels
Shelves :	One (straight version only)

Gear Edge straight	GECS-FO/FC*	📏 920 (h) x 830 (w) x 450 (d) mm
Gear Edge curved	GECC-FO/FC*	📏 920 (h) x 830 (w) x 525 (d) mm
*FO: Frame only/FC: Fabric covered - See page 118		

Gear Edge Display Counter



Fold-able counter with stylish and practical transparent acrylic showcase area, perfect for displaying and protecting products.

Material :	Aluminium, MDF tabletop/base, acrylic shelf
Assembly :	Fold-able (standard), Allen key if graphics change
Collapsible :	Yes
Counter top :	Transparent
Graphic attachment :	Infill panels (for 3-5mm substrate - optional extra) Hook and loop if fixing onto fabric panels
Shelves :	One

Gear Edge Display	GECD-FO/FC*	📏 920 (h) x 775 (w) x 405 (d) mm
*FO: Frame only/FC: Fabric covered - See page 118		

Four colours available:



Change the graphic panel, change your offer message



I deal for displaying products



Curved version



Storage shelving (straight version only)



Storage areas with sliding doors



Folds flat quickly for storage



Fabric panel options on page 118

V Counter Range



Very robust, stylish, made to order counters or workstations. Available in a choice of design configurations. The lockable storage option is ideal for applications where security is important. Cable management system included.

Material :	MDF, PVC
Assembly :	Stand-offs
Collapsible :	No
Counter top :	Beech / black / silver / white
Graphic attachment :	Screw-in Fascia kit - optional extra
Shelves :	One (Deluxe version)
Bag :	One carry case - optional extra

Standard Ellipse	PK30SE	Ⓞ 1020 (h) x 950 (w) x 520 (d) mm
Standard Keystone	PK30SK	Ⓞ 1020 (h) x 900 (w) x 550 (d) mm
Deluxe Ellipse	PK30DE	Ⓞ 1020 (h) x 900 (w) x 520 (d) mm
Deluxe Keystone	PK30DK	Ⓞ 1020 (h) x 950 (w) x 550 (d) mm

Accessories :

Carry case	AC347A	Ⓞ N/A
iPad Holder (white)	IPDM-W*	Ⓞ 305 (h) x 230 (w) mm
iPad Holder (silver)	IPDM-S*	Ⓞ 305 (h) x 230 (w) mm
iPad Holder (black)	IPDM-B*	Ⓞ 305 (h) x 230 (w) mm
Fascia Kit	PK30FK	Ⓞ N/A

1 Choose your counter style



Standard Version:
With open back



Deluxe Version:
Internal shelf and
lockable door

2 Choose your tabletop shape

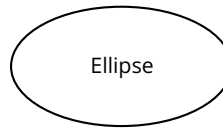

Ellipse

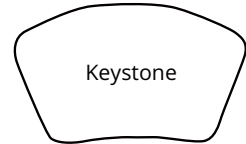

Keystone

3 Choose the colour of the counter

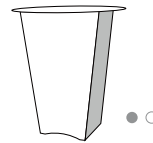

PVC panels (sides) are available in two colours: grey or white

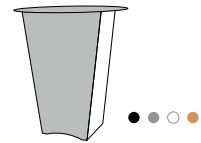

Rigid MDF panels (tabletop, front and back) of the counter available in four colours: black, grey, white, beech

4 Choose from three optional accessories



Optional LCD screen support* available on request.

Deluxe counter shown with Keystone top, silver side panels and beech finish.

*Please note LCD screen is not included and not available to purchase



Optional flush mounted iPad holder* available in three colours: white, silver and black.

Optional Fascia Kit. Standard counter shown with Keystone top, acrylic fascia panel, silver side panels and beech finish.

Standard counter shown with Ellipse top, silver side panels and beech finish.

*Please note all tablets and iPads are not included and not available to purchase



Optional Fascia Kit.

Standard counter shown with Keystone top, acrylic fascia panel, silver side panels and beech finish.

Basics Round Counter



Simple and effective basic counter – perfect for exhibitions and road shows. Reversible colour thermoformed top and base with grey corex fluted wrap.

Material :	MDF tabletop/base, Corex wrap
Assembly :	Push-fit - Tool-free
Collapsible :	No
Counter top :	Beech / black
Graphic attachment :	Hook and loop wrap
Shelves :	No
Bag :	Two carry bags - included

Basics Round Counter beech/black	PK923	Ⓢ 926 (h) x 450 (Ø) mm
Basics Round Counter beech/black	PK923-BLK	Ⓢ 926 (h) x 450 (Ø) mm



Beech tabletop



Tabletops and bases are reversible



Carry bags

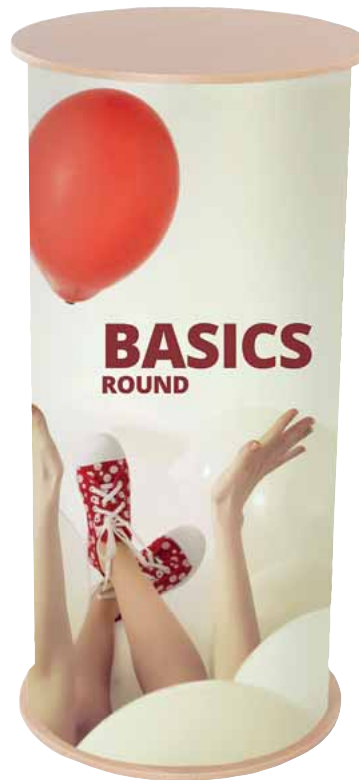

Cost effective counter solution

Reversible counter



Basics Curved Counter



Stylish and functional Double-D-shaped counter. Simple to assemble making it ideal for any lounges or reception areas. Reversible colour thermoformed tops and bases with grey corex fluted wrap.

Material :	MDF tabletop/base, Corex wrap
Assembly :	Push-fit - Tool-free
Collapsible :	No
Counter top :	Beech / black
Graphic attachment :	Hook and loop wrap
Bag :	Two carry bags - included

Basics Curved Counter beech/black	PK922	Ⓢ 925 (h) x 910 (w) x 480 (d) mm
Basics Curved Counter beech/black	PK922-BLK	Ⓢ 925 (h) x 910 (w) x 480 (d) mm



Large tabletop in beech/black



Rear opening for storage



Ideal for lounges or receptions



Physique Range Counters



Our largest range of portable counters, available in fabric or with a graphic (available for most designs). We can also manufacture to your specification - please ask for details.

Material :	MDF / Aluminium
Assembly :	Push-fit
Collapsible :	No
Counter top :	Beech / black / silver / white
Graphic attachment :	Freestyle MDF tambour wrap/graphic wrap See product descriptions for details
Shelves :	See product descriptions for details
Bag :	See product descriptions for details

1 Choose your counter style

Choose from one of the six counter styles in the Physique range: Luna, Eclipse, Curved Workstation, Mercury, Comet or Double D.

2 Choose your assembly option

MDF Freestyle

MDF Tambour wrap counter, finished in a choice of fabric covering (See Step 3). Supports maximum load of 75kg. Graphics attach directly to fabric with hook and loop.

Available for all products.



Physique Pole Graphic

Lightweight structure made with unique twist and lock aluminium pole system and graphics that attach directly to the unit.

Available for Double D, Eclipse and Curved Workstation.



3 Choose the fabric type and colour

Choose from the two options; Luxury Foam Backed Nylon or Smooth (formerly Prelude). See all available colour options on page 118.

4 Choose the tabletop and base colour

Tabletop and base are available in four colours:
Beech, black, silver or white.



5 Choose to accessorise with a flush mounted tabletop iPad* Holder

Available for all products and suitable for iPad 2,3,4 and Air* and holder available in three colours : Black and white



Add an iPad holder to complete the look! →



Curved Workstation

Sturdy counter with both open back and full wrap options available. Lockable doors, shelving and graphic wrap available as optional extras.

Freestyle	PK160	⊗ 1000 (h) x 1000 (w) x 500 (d) mm
Pole graphic	PT160	⊗ 1000 (h) x 1000 (w) x 500 (d) mm

Accessories :

iPad Holder	IPDM	⊗ 305 (h) x 230 (w) mm
Lockable door*	RK322	⊗ N/A
Internal shelf	RK303	⊗ N/A
Case	AC312	⊗ N/A
Carry bag	AB115A	⊗ N/A

*Lockable door option isn't compatible with pole graphic assembly option



Eclipse

Robust counter with large storage capacity. Ideal for use as workstation or product display unit. Available as a full graphic wrap only.

Freestyle	PK152	⊗ 1000 (h) x 1000 (w) x 500 (d) mm
Pole graphic	PT152	⊗ 1000 (h) x 1000 (w) x 500 (d) mm

Accessories :

iPad Holder	IPDM	⊗ 305 (h) x 230 (w) mm
Carry bag	AB112A	⊗ N/A
Case	AC311	⊗ N/A



Luna

Lightweight portable counter, ideal for road shows with low-profile shape and fine-grade fluted tambour for a smoother finish. Twist and lock poles for added strength, integral shelf included.

Fabric covered	PK113-F	Ⓞ 1000 (h) x 860 (w) x 400 (d) mm
Corex	PK113-W	Ⓞ 1000 (h) x 860 (w) x 400 (d) mm

Accessories :

iPad Holder	IPDM	Ⓞ 305 (h) x 230 (w) mm
Carry bag	CBB-005	Ⓞ N/A
Case	AC311	Ⓞ N/A



Double D

Great all rounder counter available as open back and full wrap. Lockable door and graphic wrap available as optional extras. Please ask for advice on lockable door.

Freestyle	PK161	Ⓞ 1000 (h) x 1000 (w) x 500 (d) mm
Pole graphic	PT161	Ⓞ 1000 (h) x 1000 (w) x 500 (d) mm

Accessories :

iPad Holder	IPDM	Ⓞ 305 (h) x 230 (w) mm
Carry bag	AB112A	Ⓞ N/A



Ideal station counter for presentations

Mercury*

Versatile counter with LCD mount (up to 20"), acrylic shelf and cable management port included. Only the freestyle option is available, but can have full wrap or open back.

Freestyle	PK190	Ⓞ 1520 (h) x 850 (w) x 600 (d) mm
-----------	-------	-----------------------------------

Accessories :

Internal shelf	PK190T	N/A
iPad Holder	IPDM	Ⓞ 305 (h) x 230 (w) mm
Carry bag	AB115B	Ⓞ N/A

Available without banner



iPad Holder optional extra



PK189A

Comet*

Stylish tear drop counter, available with Design iPad* holder and 360° mount option but shown with integral literature holder. Only the freestyle option is available.

Freestyle	PK189	Ⓞ 1010 (h) x 1010 (w) x 655 (d) mm
Freestyle with graphic	PK189A	Ⓞ 1800 (h) x 1010 (w) x 655 (d) mm

Accessories :

Design iPad Holder + 360° mount (silver)	IPAD-SH-360S	Ⓞ N/A
Carry bag	AB115B	Ⓞ N/A

Tornado



Lightweight, weatherproof and durable curved outdoor or indoor promotional counter with water drainage notches. Support poles and header panel available as optional extra.

Material :	Moulded HDPE, PVC tambour
Assembly :	Push-fit - Tool-free
Collapsible :	No
Counter top :	No
Graphic attachment :	Push-in
Shelves :	No
Bag :	Two carry bags - optional extra

Tornado	PK410	📏 1040 (h) x 850 (w) x 500 (d) mm
---------	-------	-----------------------------------

Accessories :

Header and poles	PK411	📏 250 (h) x 600 (w) x 20 (d) mm
Tabletop and base bag	AB187	📏 N/A
Graphic wrap bag	AB187A	📏 N/A

Add an optional extra header for more brand exposure



Base can be weighted using water or sand for outdoor use



Tabletop and base bag optional extra



Graphic wrap bag optional extra



Internal storage area

Counta



Indoor white, PVC, lightweight, portable demonstrator unit which includes header panel and shelf supporting poles. Graphics can be applied as vinyl directly onto the base wrap.

Material :	PVC
Assembly :	Push-fit - Tool-free
Collapsible :	Yes
Counter top :	No
Graphic attachment :	Push-in
Shelves :	One
Bag :	One carry bag

Counta	PC607	📏 2195 (h) x 8050 (w) x 450 (d) mm - Assembled
		📏 280 (h) x 680 (w) x 20 (d) mm - Header

Promotional counter, ideal for retail use



Shelving and storage area at reverse

Carry bag included for transportation or safe storage of your Counta



Backwalls

Our Backwall products include our Hop-up and Pop-up displays and Formulate also. They provide a simple way to create stunning backdrops, exhibition stands and displays.

They are lightweight, compact and practical, with cleverly designed systems that set up in minutes. Graphics are easily attached to a Pop-up or Formulate frame or left in place on a Hop-up.

Our range also allows for creative use of larger spaces, with linkable displays and large-scale graphics.





Choose a Backwall to create stunning visual impact.

Our Backwalls are large in stature but are also extremely portable and easy to use. Highly popular for events, commercial galleries, lounge road shows or just used as interior decoration, they are a creative backdrop for many situations.

Before choosing your backwall, ask yourself:

1. What size is the area you need to cover?
2. What shape of Backwall is required?
3. What type of print media would you like to use?
4. How often will your display need to be refreshed or re-branded?
5. Does your Backwall display need to be reconfigurable?
6. How portable does your backwall display need to be?
7. Will lighting be required for your display?
8. How will your Backwall be transported?

Our range of display Backwalls



Impact / Quick+

Magnetic locking arms create an easy to use Pop-up frame structure. PVC graphics are held perfectly in position on the frame using graphic magnetic strips. Single or double-sided graphic option is available and Pop-ups can also be accessorised with lights and cases that convert to counters.



Embrace

Embrace is our Silicone Edge Graphic (SEG) Pop-up system with push-fit seamless fabric graphics, which hug a collapsible lightweight frame giving a sharp crisp image. Available in four sizes, Embrace allows you to erect a sophisticated display in minutes! Multiple frames can also be joined together to create larger seamless displays.



Hop-Up

A lightweight Hop-up frame system with locking arms. Fabric graphics fit smoothly across the framework and attach in place once the frame has been collapsed using hook and loop attachments. Hop-ups can also be accessorised with overhead lights.



Xclaim

This is a simple lightweight, collapsible frame with magnetic locking arms and push-fit fabric graphics. Coming in a variety of shapes and sizes, Xclaim is designed to be portable and durable and can be set up and packed down quickly and easily.



Formulate

A range of standard or custom structures, manufactured from strong yet lightweight tubular aluminium, providing a simple and portable framework which can be dressed with a tensioned fabric graphic.

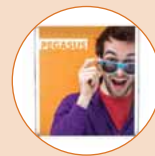

Pegasus

This great range of adjustable tension backwalls have telescopic poles for adjusting the height and width, so they can fit all spaces and graphic sizes. Composed of lightweight aluminium tubes which the graphics slide onto.

Graphics stay in place with magnetic strips

Impact Straight or Curved Pop-up



Great economic frame system backwall. Suitable for use in daily changing locations such as roadshows or in fixed spaces such as commercial galleries, showrooms or used just for interior decoration.

- Material :** Aluminium structure, plastic connectors
- Assembly :** Magnetic connectors
- Shape :** Straight or curved
- Graphic attachment :** Mag bars, hangers and kickers
- Graphic :** Single-sided (with or without D-ends) / double-sided (optional)
- Utilisation :** Free-standing

Impact 3x1 Curved	IMP-3X1C	⊗ 2225 (h) x 1240 (w) x 306 (d) mm
Impact 3x2 Curved	IMP-3X2C	⊗ 2225 (h) x 1930 (w) x 485 (d) mm
Impact 3x3 Curved	IMP-3X3C	⊗ 2225 (h) x 2540 (w) x 685 (d) mm
Impact 3x4 Curved	IMP-3X4C	⊗ 2225 (h) x 3070 (w) x 960 (d) mm
Impact 3x5 Curved	IMP-3X5C	⊗ 2225 (h) x 3430 (w) x 1225 (d) mm
Impact 3x1 Straight	IMP-3X1S	⊗ 2225 (h) x 1240 (w) x 306 (d) mm
Impact 3x2 Straight	IMP-3X2S	⊗ 2225 (h) x 1970 (w) x 306 (d) mm
Impact 3x3 Straight	IMP-3X3S	⊗ 2225 (h) x 2700 (w) x 306 (d) mm
Impact 3x4 Straight	IMP-3X4S	⊗ 2225 (h) x 3435 (w) x 306 (d) mm
Impact 3x5 Straight	IMP-3X5S	⊗ 2225 (h) x 4160 (w) x 306 (d) mm

Impact 3x2 Curved Bundle	99-XX-110	⊗ 2225 (h) x 1930 (w) x 485 (d) mm
Impact 3x3 Curved Bundle	99-XX-071	⊗ 2225 (h) x 2540 (w) x 685 (d) mm
Impact 3x4 Curved Bundle	99-XX-070	⊗ 2225 (h) x 3070 (w) x 960 (d) mm
Impact 3x5 Curved Bundle	99-XX-111	⊗ 2225 (h) x 3430 (w) x 1225 (d) mm
Impact 3x1 Straight Bundle	99-XX-105	⊗ 2225 (h) x 1240 (w) x 306 (d) mm
Impact 3x2 Straight Bundle	99-XX-106	⊗ 2225 (h) x 1970 (w) x 306 (d) mm
Impact 3x3 Straight Bundle	99-XX-107	⊗ 2225 (h) x 2700 (w) x 306 (d) mm
Impact 3x4 Straight Bundle	99-XX-108	⊗ 2225 (h) x 3435 (w) x 306 (d) mm
Impact 3x5 Straight Bundle	99-XX-109	⊗ 2225 (h) x 4160 (w) x 306 (d) mm



Available in curved or straight

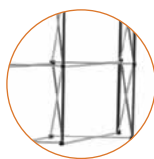

Aluminium frame system



Magnetic connectors



Self-locating 'smart' magnetic locking arms



Magnetic bars



Impact Bundle

Impact Kit

						
Carry bag	Straight or curved frame system	Hangers, kickers and mag bars	1x roll of self-adhesive magnetic tape	Zenith transit case	Thermoformed table top in beech	2x PS950-1000 LED light

Quick+ Straight or Curved Pop-up



Premium full magnetic system backwall with self-locating 'smart' magnetic locking arms and adjustable magnetic hanger fittings. Custom sizes on request.

Material :	Aluminium structure, plastic connectors
Assembly :	Magnetic connectors
Shape :	Straight or curved
Graphic attachment :	Mag bars, hangers and kickers
Graphic :	Single-sided (with or without D-ends) / double-sided (optional)
Utilisation :	Free-standing

Kit Quick+ 3x1 Curved	WH221-C-CA	⊗ 2225 (h) x 1240 (w) x 306 (d) mm
Kit Quick+ 3x2 Curved	WH222-C-CA	⊗ 2225 (h) x 1930 (w) x 485 (d) mm
Kit Quick+ 3x3 Curved	WH223-C-CA	⊗ 2225 (h) x 2540 (w) x 685 (d) mm
Kit Quick+ 3x4 Curved	WH224-C-CA	⊗ 2225 (h) x 3070 (w) x 960 (d) mm
Kit Quick+ 3x5 Curved	WH225-C-CA	⊗ 2225 (h) x 3430 (w) x 1225 (d) mm
Kit Quick+ 3x1 Straight	WH221-S-CA	⊗ 2225 (h) x 1240 (w) x 306 (d) mm
Kit Quick+ 3x2 Straight	WH222-S-CA	⊗ 2225 (h) x 1970 (w) x 306 (d) mm
Kit Quick+ 3x3 Straight	WH223-S-CA	⊗ 2225 (h) x 2700 (w) x 306 (d) mm
Kit Quick+ 3x4 Straight	WH224-S-CA	⊗ 2225 (h) x 3435 (w) x 306 (d) mm
Kit Quick+ 3x5 Straight	WH225-S-CA	⊗ 2225 (h) x 4160 (w) x 306 (d) mm

Available in custom sizes



Available in straight or curved



Quick+ Straight or Curved Pop-up Bundles

Quick+ 3x2 Curved Bundle	99-XX-016Q	⊗ 2225 (h) x 1930 (w) x 485 (d) mm
Quick+ 3x3 Curved Bundle	99-XX-017Q	⊗ 2225 (h) x 2540 (w) x 685 (d) mm
Quick+ 3x4 Curved Bundle	99-XX-020Q	⊗ 2225 (h) x 3070 (w) x 960 (d) mm
Quick+ 3x5 Curved Bundle	99-XX-021Q	⊗ 2225 (h) x 3430 (w) x 1225 (d) mm
Quick+ 3x2 Straight Bundle	99-XX-101Q	⊗ 2225 (h) x 1970 (w) x 306 (d) mm
Quick+ 3x3 Straight Bundle	99-XX-102Q	⊗ 2225 (h) x 2700 (w) x 306 (d) mm
Quick+ 3x4 Straight Bundle	99-XX-103Q	⊗ 2225 (h) x 3435 (w) x 306 (d) mm
Quick+ 3x5 Straight Bundle	99-XX-104Q	⊗ 2225 (h) x 4160 (w) x 306 (d) mm

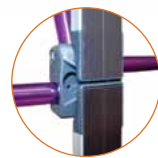

Square end magnetic bars



Magnetic connectors

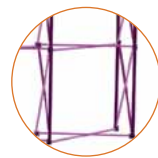







Purple aluminium structure and adjustable feet for levelling on uneven flooring



Lights fit directly on to the frame system. Suitable for LED PS950-1000 lights

Quick+ Bundle

<p>Quick+ Kit</p>  <p>Carry bag</p>	 <p>Straight or curved frame system</p>	 <p>Hangers, kickers and mag bars</p>	 <p>1x roll of self-adhesive magnetic tape</p>	 <p>Zenith transit case</p>	 <p>Thermoformed table top in beech</p>	 <p>2x PS950-1000 LED light</p>
-------------------------------------------------------------------------------------------------------------------------------	----------------------------------------------------------------------------------------------------------------------------	--------------------------------------------------------------------------------------------------------------------------	-----------------------------------------------------------------------------------------------------------------------------------	------------------------------------------------------------------------------------------------------------------	------------------------------------------------------------------------------------------------------------------------------	----------------------------------------------------------------------------------------------------------------------

Quick+ Tower



Get your message noticed 360° with a Quick Tower Pop-up. At almost 3m* in height and with the option to accessorise with lighting it makes a great impact in a small space.

- Material :** Aluminium structure, magnetic connectors
- Assembly :** Magnetic connectors
- Shape :** Round
- Graphic attachment :** Mag bars, hangers and kickers
- Graphic :** 360°
- Utilisation :** Free-standing

3 Quads (h)	WH231A-C	⊗, 2255 (h) x 640 (Ø) mm
4 Quads (h)*	WH232A-C	⊗, 2985 (h) x 640 (Ø) mm

360°



Make your tower light up with optional PS1200 fluorescent tubes



Self-attracting, easy to hook in magnetic top graphics



Magnetic connectors

Accessorise your Impact / Quick backwalls

Increase the visual impact of your stands with our accessories

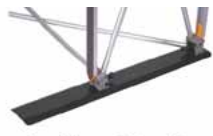

Pop-up Stabilising feet ES505

Recommended for straight Pop-up systems where internal or external load-bearing shelving is used



Pop-up Fabric

Hard wearing fabric panels, ideal for big-impact notice boards. Use plain or add graphics using hook fastenings. See page 118 for colour choices.



LCD Screen Bracket* PUSMK1/2/3

Add audio visual to your stand using an LCD screen bracket*, (supports screens up to 540mm or 5kg)



Pop-up Shelving ES514-A = Curved ES514-002 = Straight



Internal Shelf ES511X-C = Curved acrylic ES511-S = Straight acrylic Supports up to 10 kg. Recommended with optional stabilising feet.



Pop-up Shelving Aperture Infill Panel ES512 - Curved ES513 - Straight



Fluorescent Tube PS1200 Light up your backwall with a linkable 20 watt fluorescent lighting and Linking cable (US601B)

*Please note that screens are not included and are not available for purchase.



Embrace Eco



Available from
Summer 2019

    Available from Summer 2019

Economical solution combining the practicality of a frame system stand and tension fabric graphics attached with silicone edged gaskets (SEG).

Material :	Aluminium structure, plastic connectors
Assembly :	Locking by clips, interlocking frame sections
Graphic attachment :	SEG 3mm
Shape :	Straight
Graphic :	Single-sided (with or without returns) or double-sided (optional)
Utilisation :	Free-standing

Embrace Eco 3x2	EMB-ECO-3X2-S	⊗ 2245 (h) x 1510 (w) x 344 (d) mm
Embrace Eco 3x3	EMB-ECO-3X3-S	⊗ 2245 (h) x 2245 (w) x 344 (d) mm
Embrace Eco 3x4	EMB-ECO-3X4-S	⊗ 2245 (h) x 2980 (w) x 344 (d) mm

Accessories :

Feet (pair)	EMB-ECO-FEET	⊗ N/A
-------------	--------------	-------

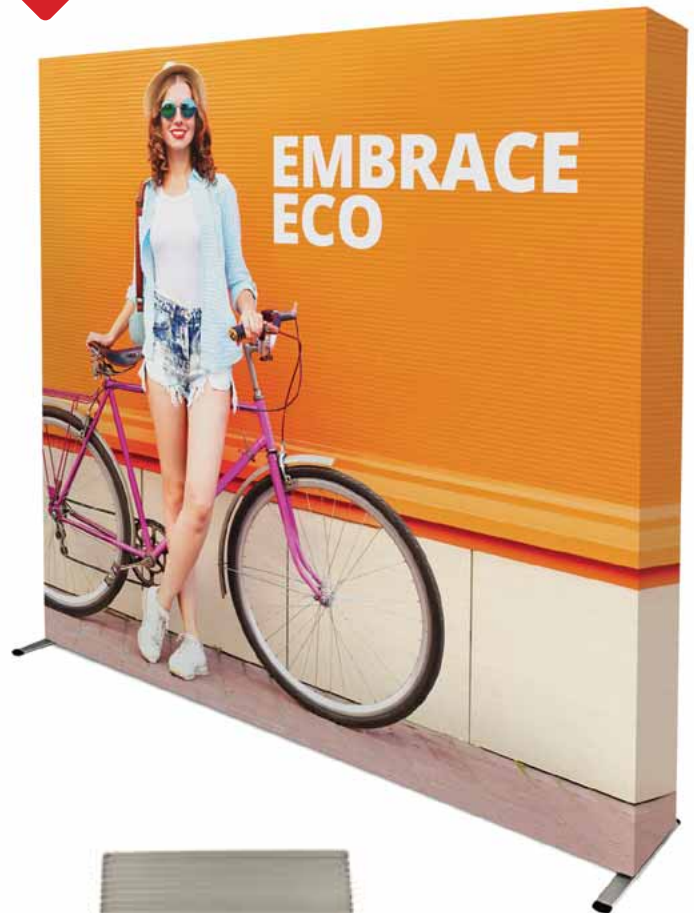

Optional
stabilising
feet



Compact
frame
structure



Frame system
structure



Simple push-fit
connections



Lock together
with clips



Channel bars for
push-fit SEG tension
fabric graphics



Metal latch to
secure the foot



Padded carry bag
with pockets

Premium LED display system

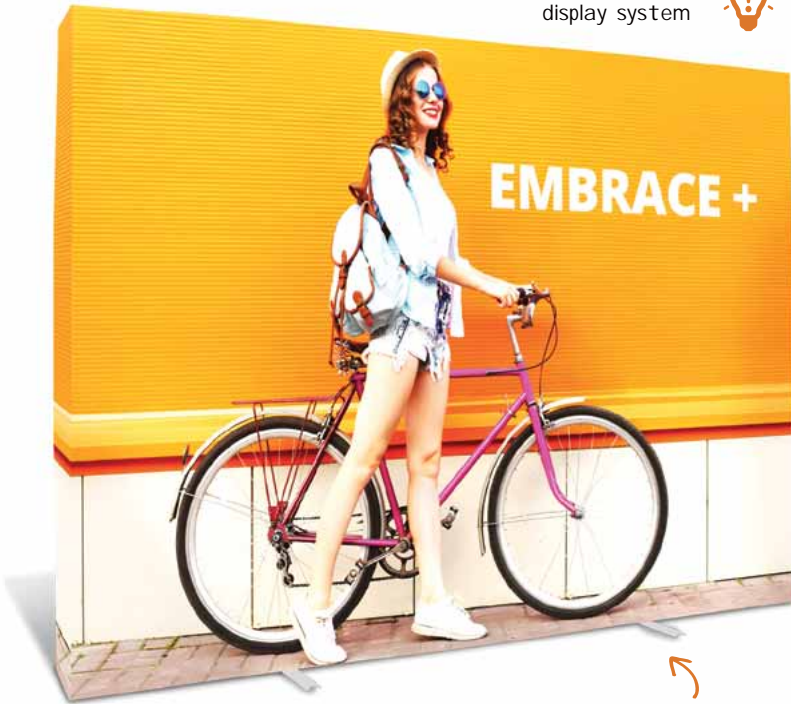

Embrace+



Premium LED backlit double-sided display system with SEG tension fabric graphics. Perfect for exhibition environments to make a real impact. Make larger or shaped backwalls by clamping structures together or at right angles.

Material : Aluminium structure, plastic connectors
Assembly : Locking by clips, interlocking frame sections
Graphic attachment : SEG 3mm
Shape : Straight
Graphic : Single-sided (with or without returns) or double-sided (optional)
Utilisation : Free-standing

Embrace+ 3X1	EMB-PL-3X1-S	⊗ 2255 (h) x 790 (w) x 410 (d) mm
Embrace+ 3X2	EMB-PL-3X2-S	⊗ 2255 (h) x 1523 (w) x 410 (d) mm
Embrace+ 3X3	EMB-PL-3X3-S	⊗ 2255 (h) x 2239 (w) x 410 (d) mm
Embrace+ 3X4	EMB-PL-3X5-S	⊗ 2255 (h) x 2972 (w) x 410 (d) mm
Embrace+ 4X1	EMB-PL-4X1-S	⊗ 2957 (h) x 790 (w) x 410 (d) mm
Embrace+ 4X2	EMB-PL-4X2-S	⊗ 2957 (h) x 1523 (w) x 410 (d) mm
Embrace+ 4X3	EMB-PL-4X3-S	⊗ 2957 (h) x 2239 (w) x 410 (d) mm
Embrace+ 4X4	EMB-PL-4X4-S	⊗ 2957 (h) x 2972 (w) x 410 (d) mm

Impressive tall backwall

Optional stabilising feet



Bungeed sections



Lock together with clips



Height adjustable



Channel on frame for push-fit SEG tension fabric graphics

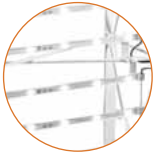

Easy hook on LED curtains



Optional aperture infill shelf and spot light



Optional external shelving



Optional screen holder*

Accessories :

Feet (pair)	EMB-PL-FEET-W	⊗ 735 x 60 mm
-------------	---------------	---------------

*Please note that screens are not included and are not available for purchase.

3 Quads high

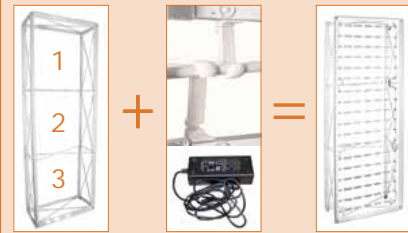

Frame system EMB-PL-3X1-S

1x LED lighting curtain for 3 vertical quads EMB-PL-LED-3X1-UK

Backlit 3x1 Embrace+

Ready for fabric SEG graphics (optional extra)



Accessorise with optional shelves or screen-holder*



Optional internal aperture infill panel shelving



Bag included (wheeled except 3x1 and 4x1)

4 Quads high

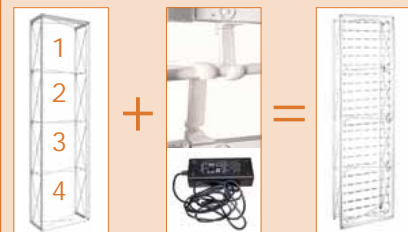

Frame system EMB-PL-4X1-S

1x LED lighting curtain for 4 vertical quads EMB-PL-LED-4X1-UK

Backlit 4x1 Embrace+

Ready for fabric SEG graphics (optional extra)

Simple quick assembly with optional tension fabric SEG graphics



Hop-up Impact Straight



Popular frame system that's quick to install with optional tension fabric graphics that stays on the frame structure once packed and folded. Also available in custom sizes.

Material :	Aluminium structure, plastic connectors
Assembly :	Lock together with clips
Shape :	Straight
Graphic attachment :	Hook and loop
Graphic :	Single-sided (with or without returns) or double-sided (optional)
Utilisation :	Free-standing

3x1 Quads	HUI3X1	⊗ 2260 (h) x 790 (w) x 295 (d) mm
3x2 Quads	HUI3X2	⊗ 2260 (h) x 1525 (w) x 295 (d) mm
3x3 Quads	HUI3X3	⊗ 2260 (h) x 2260 (w) x 295 (d) mm
3x4 Quads	HUI3X4	⊗ 2260 (h) x 2995 (w) x 295 (d) mm
3x5 Quads	HUI3X5	⊗ 2260 (h) x 3730 (w) x 295 (d) mm

Accessories :

Stabilising feet (pair)	E5508	⊗ N/A
-------------------------	-------	-------



Easily to transport



Plastic connectors



Graphics affix with hook and loop



Wheeled bag

Assembles in two minutes!



Custom sizes available



Hop-up Impact Curved



Curved frame system and optional fabric graphics. Quick and simple to deploy. Compact and lightweight to transport or store.

Material :	Aluminium structure, plastic connectors
Assembly :	Lock together with clips
Shape :	Curved
Graphic attachment :	Hook and loop
Graphic :	Single-sided (with or without returns)
Utilisation :	Free-standing

3x3 Quads	HOP-2-3X3-C	⊗ 2260 (h) x 2310 (w) x 570 (d) mm
3x4 Quads	HOP-2-4X3-C	⊗ 2260 (h) x 2950 (w) x 810 (d) mm

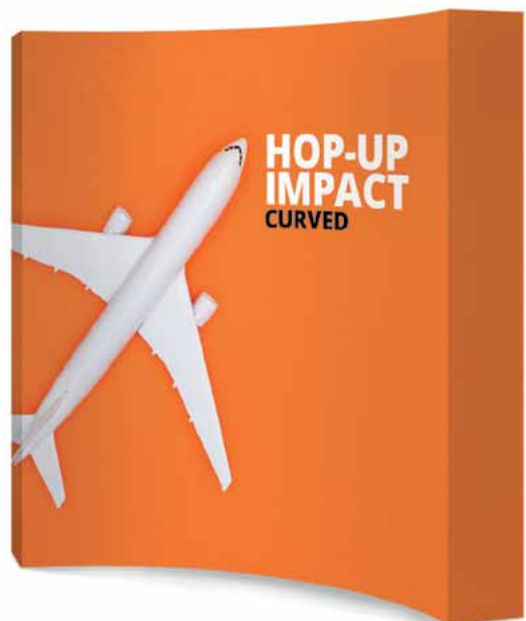

Easy to transport



Plastic connectors



Graphics affix with hook and loop

Xclaim



One hardware structure with many fabric graphic configurations! Combine different fabric graphic sizes and shapes to create original displays and effects.

- Material :** Aluminium structure, plastic connectors
- Assembly :** Magnetic connectors
- Shape :** Straight
- Graphic attachment :** Push-fit
- Graphic :** Single-sided or double-sided
- Utilisation :** Free-standing

3x3 Quads	XCLM-3X3	Ⓞ 2250 (h) x 2250 (w) x 315 (d) mm
Shape cross	XCLM-SQP	Ⓞ 2130 (h) x 2130 (w) x 315 (d) mm

Interchangeable graphics

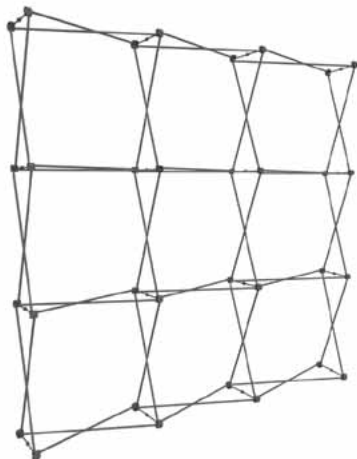

Easily collapsible frame system, quick to deploy and pack away

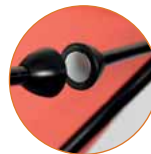

Magnetic connectors



Fabric graphics attach using push-fit points



Attach multiple graphic panels to each push-fit point



Keep displays fresh by varying configurations

The shape and size of the graphics can be re-arranged or changed for a new style.

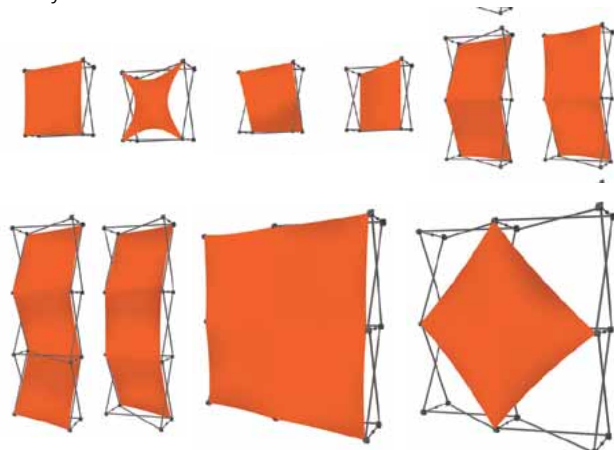

Formulate

When display formats become common place and no longer stand out then choose something with innovative shapes ...

The Formulate range offers a variety of great shapes with clean lines, ideal for creating picture backwalls or defining areas in rooms by screening or zoning.

The double-sided tension fabric graphics perfectly contour the shaped aluminium structures and maximize your brand message. Formulate structures as well as being versatile, are also multifunctional when accessorised with LED lighting, iPad holders, shelving and leaflet holders (see pages page 86 and page 113).



Push-fit button connections on bungeed aluminium tubing



Numbered tubes for easy assembly

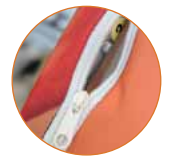

Zip close at base



Optional LED lighting available



Padded carry bag included



Gloves included to keep your graphics clean during assembly

Additional new sizes

Formulate Straight



Material :	Aluminium tubing
Tube diameter :	30mm
Assembly :	Push-fit button
Shape :	Straight
Graphic attachment :	Zipped
Graphic :	Double-sided
Utilisation :	Free-standing with feet (included)

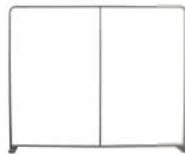

2400 mm	FORM-STR-24	Ⓞ 2380 (h) x 2350 (w) x 400 (d) mm
3000 mm	FORM-STR-30	Ⓞ 2380 (h) x 2950 (w) x 400 (d) mm
NEW 4000 mm	FORM-STR-40	Ⓞ 2380 (h) x 3950 (w) x 400 (d) mm
NEW 5000 mm	FORM-STR-50	Ⓞ 2380 (h) x 4950 (w) x 400 (d) mm
6000 mm	FORM-STR-60	Ⓞ 2380 (h) x 5950 (w) x 400 (d) mm

Formulate Serpentine



Material :	Aluminium tubes
Tube diameter :	30mm
Assembly :	Push-fit button
Shape :	Wave
Graphic attachment :	Zipped
Graphic :	Double-sided
Utilisation :	Free-standing with feet (included)



I deal shape for dividing large spaces

2400 mm	FORM-SER-24	Ⓞ 2380 (h) x 2350 (w) x 608 (d) mm
3000 mm	FORM-SER-30	Ⓞ 2380 (h) x 2950 (w) x 608 (d) mm



Formulate Vertical Curve



Material :	Aluminium tubes
Tube diameter :	30mm
Assembly :	Push-fit button
Shape :	Vertical curve
Graphic attachment :	Zipped
Graphic :	Double-sided
Utilisation :	Free-standing with feet (included)

2400 mm	FORM-VCU-24	📏 2380 (h) x 2350 (w) x 608 (d) mm
3000 mm	FORM-VCU-30	📏 2380 (h) x 2950 (w) x 608 (d) mm



Stabilising feet



Formulate Horizontal Curve



Material :	Aluminium tubes
Tube diameter :	30mm
Assembly :	Push-fit button
Shape :	Horizontal curve
Graphic attachment :	Zipped
Graphic :	Double-sided
Utilisation :	Free-standing

2400 mm	FORM-CUR-24	📏 2380 (h) x 2350 (w) x 500 (d) mm
3000 mm	FORM-CUR-30	📏 2380 (h) x 2950 (w) x 500 (d) mm
6000 mm	FORM-CUR-60	📏 2380 (h) x 5950 (w) x 900 (d) mm

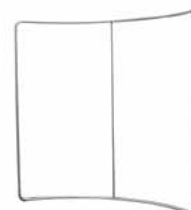

Up to 6m wide

Formulate Meeting Pod



Material :	Aluminium tubes
Tube diameter :	30mm
Assembly :	Push-fit button
Shape :	Curved
Graphic attachment :	Zipped
Graphic :	Double-sided
Utilisation :	Free-standing

Meeting Pod	FORM-MPOD-01	Ⓞ 2100 (h) x 2900 (w) x 2550 (d) mm
-------------	--------------	-------------------------------------



Create a private break-away area

Formulate Arch



Material :	Aluminium tubes
Tube diameter :	30mm
Assembly :	Push-fit button
Shape :	Arch
Graphic attachment :	Zipped
Graphic :	Double-sided
Utilisation :	Free-standing

Arch	FORM-ARCH-01	Ⓞ 3000 (h) x 4000 (w) x 900 (d) mm
------	--------------	------------------------------------

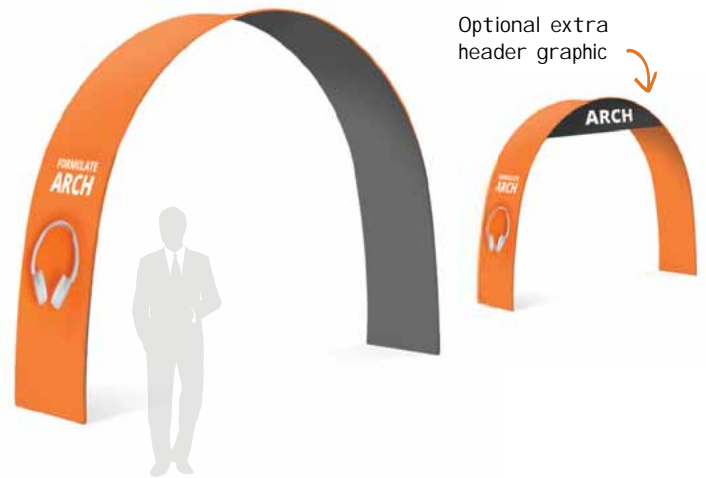

Optional extra header graphic

Formulate Accessories

Bring more functionality to Formulate structures by using iPad holders, shelves and leaflet holders...

Our accessory system has been designed to give you the freedom to add and change items whenever you need them.



Universal Accessory Clamp

Universal clamp	FMLT158
-----------------	---------



Light Fitting

Tube light fitting 30mm	US903
-------------------------	-------



iPad Holders

Frame compatible with all iPads except iPad mini and Pro. Use with FMLT158 clamp.

iPad support	FX837	
iPad Holder in white	IPAD-CHU-W	Ⓞ 305 (h) x 70 (w) x 40 (d) mm
iPad Holder in black	IPAD-CHU-B	Ⓞ 305 (h) x 70 (w) x 40 (d) mm



Leaflet Holders

Use with FMLT158 clamp.

Leaflet support	FX839	
DL Leaflet holder	AH5DLP	Ⓞ DL Size (110 x 220 mm)
A5 Leaflet holder	AH5A5P	Ⓞ A5 Size
A4 Leaflet holder	AH5A4P	Ⓞ A4 Size



Shelves

Shelves are available in four colours : ● ● ● ●
Use with FMLT158 clamp.

Shelf support	FX838	
Round shelf	LN133-R	Ⓞ 12 (h) x 240 (w) x 227 (d) mm
Triangle shelf	LN133-T	Ⓞ 12 (h) x 240 (w) x 227 (d) mm
Square shelf	LN133-S	Ⓞ 12 (h) x 240 (w) x 227 (d) mm

Pegasus



Telescopic poles create a large image area adjustable up to 2.5m ideal for photography displays. Extremely lightweight, it packs down into a compartmented padded bag.

- Material : Aluminium
- Assembly : Telescopic twist-lock poles
- Shape : Straight
- Graphic attachment : Pole pocket
- Graphic : Single or double-sided
- Utilisation : Free-standing with feet (included)

Pegasus	UB165-S	📏 1000-2515 (h) x 1429-2540 (w) x 442 (d) mm
---------	---------	----------------------------------------------



Simple and quick to install



Poles slide into graphic pole pocket

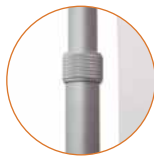

Telescopic twist-lock poles



From 1000 to 2515 mm

From 1429 to 2540 mm

Excellent value

Pegasus 3m



Our widest telescopic backwall at almost 3m offers maximum graphic impact. Lightweight, ultra-portable and simple tool free assembly.

- Material : Aluminium
- Assembly : Telescopic twist-lock poles
- Shape : Straight
- Graphic attachment : Panel pocket
- Graphic : Single or double-sided
- Utilisation : Free-standing with feet (included)

Pegasus 3 m	UB167	📏 1835-2610 (h) x 1830-3000 (w) x 440 (d) mm
-------------	-------	----------------------------------------------

Accessories :

Extension Kit	UB167-S-01	📏 1835-2610 (h) x 1830-3000 (w) x 440 (d) mm
---------------	------------	----------------------------------------------



Simple and quick to install

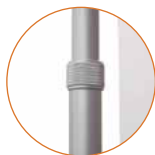

Telescopic twist-lock poles



Extension Kit



From 1830 to 3000mm

Partition an area with optional communication

Use the extension kit to create longer walls or a corner image wall



Extension kit



Pegasus 3m



Baseline Range

Panel kits form a classic range of practical, durable and reconfigurable backwall display solutions.

With a range of different finishes and media fabrics to choose from you can customise your display to match your surroundings perfectly.

Please note: our panels are guaranteed for use with hook and loop male and female tapes, these are provided by us and designed specifically for this use. We can not guarantee the panels if used with another hook and loop brand.

The baseline range offers four possible frame finishes:

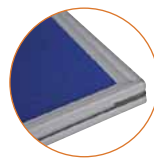

Baseline PVC (Thickness 18.2mm)

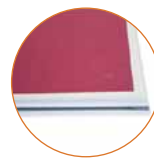

Baseline Plus PVC (Thickness 25mm)

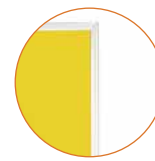

Baseline Aluminium (Thickness 18.2mm)

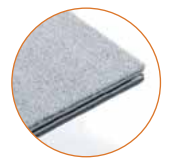

Phantom PVC (Thickness 18.2mm)

Baseline Panel and Pole Kits



Panel and pole kits* are easy to assemble and are reconfigurable and re-positionable. Available in two panel heights, stabilising feet are included. Manufactured to order.

- Material : PVC / Aluminium
- Frame : Grey / black
- Finishes : Baseline / Baseline Plus / Baseline Aluminium / Phantom
- Graphic attachment : Hook fixing
- Recommended media: Felt coating * or optional Rigid replacement printed panels (3mm)
- Graphic : Single or double-sided
- Utilisation : Free-standing with stabilising feet (included)

Each panel can be assembled horizontally or vertically

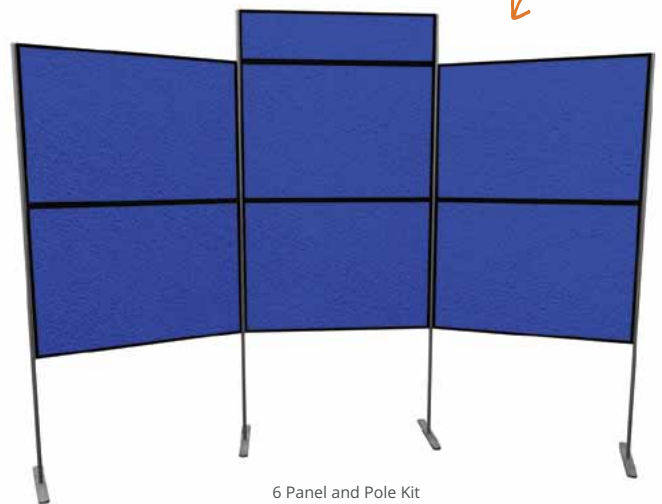

6 Panel and Pole Kit (header panel optional extra)

Reconfigurable and scalable solution

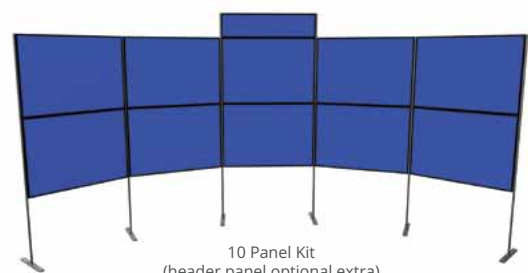

10 Panel Kit (header panel optional extra)



8 Panel Kit



10 Panel Kit

4 Panel - Baseline	KK104	⊙ 600 (h) x 900 (w) mm
4 Panel - Baseline Plus	KKP104-96	⊙ 600 (h) x 900 (w) mm
4 Panel - Aluminium	KK104A	⊙ 600 (h) x 900 (w) mm
6 Panel - Baseline	KK106	⊙ 600 (h) x 900 (w) mm
6 Panel - Baseline Plus	KKP106-96	⊙ 600 (h) x 900 (w) mm
6 Panel - Aluminium	KK106A	⊙ 600 (h) x 900 (w) mm
8 Panel - Baseline	KK108	⊙ 600 (h) x 900 (w) mm
8 Panel - Baseline Plus	KKP108-96	⊙ 600 (h) x 900 (w) mm
8 Panel - Aluminium	KK108A	⊙ 600 (h) x 900 (w) mm
10 Panel - Baseline	KK110	⊙ 600 (h) x 900 (w) mm
10 Panel - Baseline Plus	KKP110-96	⊙ 600 (h) x 900 (w) mm

6 Panel - Baseline Plus	KKP106-107	⊙ 700 (h) x 1000 (w) mm
6 Panel - Phantom	KK132	⊙ 700 (h) x 1000 (w) mm
8 Panel - Baseline Plus	KKP108-107	⊙ 700 (h) x 1000 (w) mm
8 Panel - Phantom	KK134	⊙ 700 (h) x 1000 (w) mm
10 Panel - Baseline Plus	KKP110-107	⊙ 700 (h) x 1000 (w) mm
10 Panel - Phantom	KK136	⊙ 700 (h) x 1000 (w) mm

Accessories :

Circular feet black / grey	LB913B-C/S-C	⊙ N/A
Header panel	Call us	⊙ N/A

Baseline Jumbo Panel Kits



Free-standing folding panel kit* with hinges to create a screen or office partition. Manufactured to order.

- Material :** PVC / Aluminium
- Frame :** Grey / black
- Finishes :** Hook fixing
- Graphic attachment :** Felt covered corrugated board
- Recommended media:** Felt coating * or optional Rigid replacement printed panels (3mm)
- Graphic :** Single or double-sided
- Utilisation :** Free-standing

3 - Panel Baseline Plus	KKP350	Ⓞ 1800 (h) x 900 (w) mm
3 - Panel Aluminium	KK350A	Ⓞ 1800 (h) x 900 (w) mm
4 - Panel Baseline Plus	KKP351	Ⓞ 1800 (h) x 900 (w) mm
4 - Panel Aluminium	KK351A	Ⓞ 1800 (h) x 900 (w) mm

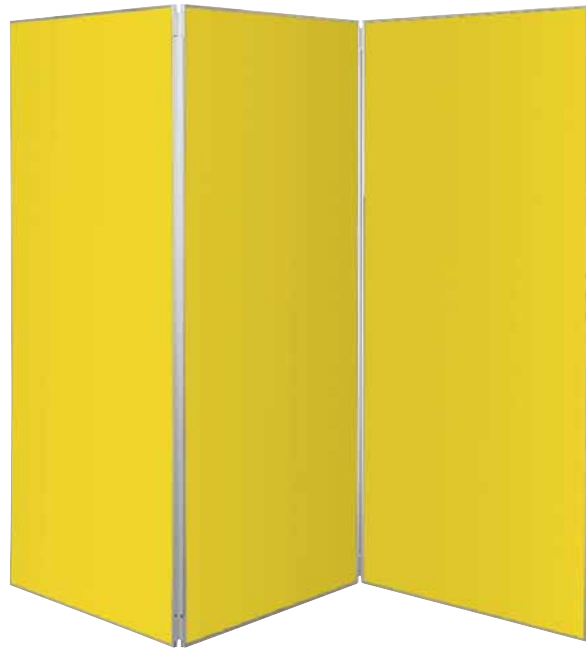

Baseline Panel Kits



Free-standing hinged panel kit. Position panels in multiple ways. Available in two panel heights. Manufactured to order.

- Material :** PVC / Aluminium
- Frame :** Grey / black
- Finishes :** Baseline / Baseline Plus / Baseline Aluminium
- Graphic attachment :** Hook fixing
- Recommended media:** Felt coating * or optional Rigid replacement printed panels (3mm)
- Graphic :** Single or double-sided
- Utilisation :** Free-standing

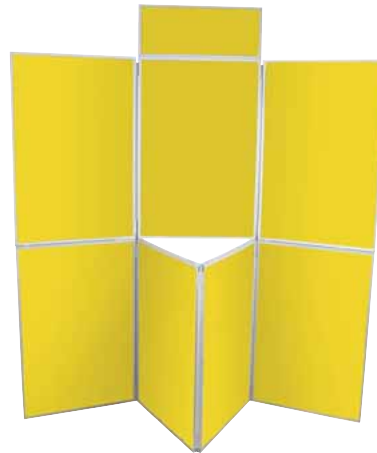

7 Panel Folding Kit



8 Panel Folding Kit + 2 Headers



6 Panel Folding Kit + Header

6 Panel - Baseline	KK117	Ⓞ 900 (h) x 600 (w) mm
6 Panel - Baseline Plus	KKP117	Ⓞ 900 (h) x 600 (w) mm
6 Panel - Aluminium	KK117A	Ⓞ 900 (h) x 600 (w) mm
7 Panel - Baseline	KK114	Ⓞ 900 (h) x 600 (w) mm
7 Panel - Baseline Plus	KKP114	Ⓞ 900 (h) x 600 (w) mm
7 Panel - Aluminium	KK114A	Ⓞ 900 (h) x 600 (w) mm
8 Panel - Baseline	KK120	Ⓞ 900 (h) x 600 (w) mm
8 Panel - Baseline Plus	KKP120	Ⓞ 900 (h) x 600 (w) mm
8 Panel - Aluminium	KK120A	Ⓞ 900 (h) x 600 (w) mm
10 Panel - Baseline	KK124	Ⓞ 900 (h) x 600 (w) mm
10 Panel - Baseline Plus	KKP124	Ⓞ 900 (h) x 600 (w) mm

6 Panel - Baseline	KK317	Ⓞ 1000 (h) x 700 (w) mm
6 Panel - Baseline Plus	KKP317	Ⓞ 1000 (h) x 700 (w) mm
6 Panel - Aluminium	Call us	Ⓞ 1000 (h) x 700 (w) mm
7 Panel - Baseline	KK314	Ⓞ 1000 (h) x 700 (w) mm
7 Panel - Baseline Plus	KKP314	Ⓞ 1000 (h) x 700 (w) mm
7 Panel - Aluminium	Call us	Ⓞ 1000 (h) x 700 (w) mm
8 Panel - Baseline	KK320	Ⓞ 1000 (h) x 700 (w) mm
8 Panel - Baseline Plus	KKP320	Ⓞ 1000 (h) x 700 (w) mm
8 Panel - Aluminium	Call us	Ⓞ 1000 (h) x 700 (w) mm
10 Panel - Baseline	KK222	Ⓞ 1000 (h) x 700 (w) mm
10 Panel - Baseline Plus	KKP222	Ⓞ 1000 (h) x 700 (w) mm



PS050-LED lighting can be fitted

*Standard or Luxury felt - See page 118 for colour choices.

Baseline Tabletop Panel kit



Folding panel kit* ideally sized for tabletops. Whiteboard coating optional on request. Manufactured to order.

Material :	PVC / Aluminium
Frame :	Grey / black
Finishes :	Baseline / Baseline Aluminium
Graphic attachment :	Hook fixing
Recommended media:	Felt coating * or optional Rigid replacement printed panels (3mm)
Graphic :	Single or double-sided
Utilisation :	Free-standing

Junior - Baseline	KK102	Centre: 600 (h) x 900 (w) mm Sides : 600 (h) x 450 (w) mm Header : 250 (h) x 900 (w) mm
Junior - Baseline Aluminium	KK102A	
Senior - Baseline	KK103	Centre: 900 (h) x 600 (w) mm Sides : 900 (h) x 450 (w) mm Header : 250 (h) x 600 (w) mm
Senior - Baseline Aluminium	KK103A	



Junior Kit

Senior Kit



Delivered with carry bag

Baseline Wheeled Panel Kits



Panel kit* with hinges and wheels with lockable casters. Ideal for creating mobile screens or temporarily zoning spaces or quickly screening off. Manufactured to order.

Material :	PVC
Frame :	Grey / black
Finishes :	Baseline Plus
Graphic attachment :	Hook fixing
Recommended media:	Felt coating * or optional Rigid replacement printed panels (3mm)
Graphic :	Single or double-sided
Utilisation :	Free-standing

5 Panel - Baseline Plus 1500 mm	KKPW5-156	Centre: 1500 (h) x 600 (w) mm
6 Panel - Baseline Plus 1500 mm	KKPW6-156	Centre: 1500 (h) x 600 (w) mm
7 Panel - Baseline Plus 1500 mm	KKPW7-156	Centre: 1500 (h) x 600 (w) mm
5 Panel - Baseline Plus 1800 mm	KKPW5-186	Centre: 1800 (h) x 600 (w) mm
6 Panel - Baseline Plus 1800 mm	KKPW6-186	Centre: 1800 (h) x 600 (w) mm
7 Panel - Baseline Plus 1800 mm	KKPW7-186	Centre: 1800 (h) x 600 (w) mm



Easy to re-arrange and move into position to screen areas

Gear Edge Panel Kits



Free-standing hinged panel kits with header included*. Kits are made from strong aluminium frames and are re-positionable. Harder wearing so ideal for more permanent displays. Manufactured to order.

Material :	Aluminium
Frame :	Silver
Graphic attachment :	Hook fixing
Recommended media:	Felt coating * (optional) or Rigid replacement printed panels (3mm)
Graphic :	Single or double-sided
Utilisation :	Free-standing

6 Panel - Printable panel	GEP6-96FO	Centre: 2050 (h) x 1500 (w) mm
6 Panel - Felt panel	GEP6-96FC	Centre: 2050 (h) x 1500 (w) mm
7 Panel - Printable panel	GEP7-96FO	Centre: 2050 (h) x 1500 (w) mm
7 Panel - Felt panel	GEP7-96FC	Centre: 2050 (h) x 1500 (w) mm
8 Panel - Printable panel	GEP8-96FO	Centre: 2050 (h) x 2100 (w) mm
8 Panel - Felt panel	GEP8-96FC	Centre: 2050 (h) x 2100 (w) mm



8 Panel Kit

Header:
229 x 568mm

Panels:
879 x 568mm



7 Panel Kit



6 Panel Kit

Modular Solutions

Exhibitions are one of the most effective showcases for your company to promote its products to your audience in the most direct way. The ability to make a great first impression is critical in order to fire the imagination of passers-by.

Our inspirational exhibition stand designs and reconfigurable solutions lead the market today.





For every space there's a Modular Solution

Modular stand designs are flexible, re-configurable and re-usable. After initial purchase you can re-use the stand as many times as you wish.

They can be re-configured to freshen the appeal, selecting the components you need for the space, purpose and location, or adding new elements to fit a new space. Graphics can also be updated to give your existing stand a fresh new look if required.



Formulate

Display structures made from lightweight 30mm or 50mm diameter aluminium tubing that combine innovative shaped structures and vibrant custom fabric printing that enhance your brand communication.



Modulate™

A range of 11 aluminium tubular frames, featuring patented MagLink magnet system and Twist & Lock feet; dressed in a custom printed tension fabric graphic. Displays can be created in an instant by placing dressed frames side-by-side and the internal magnets keep them together.



Vector

One of the most simple and versatile communication solutions on the market. The aluminium frame system with tensioned SEG textile fabric adapts to any application: hanging, wall mounted, free-standing, double-sided or lightbox frames.



Linear

The Linear range is perfect for many applications such as image walls, stands for retail or office layouts. The aluminium frames used provide the basis of a durable and solid structure, which can be used on a permanent or temporary bases.



Arena

The robust 25mm aluminium tubes of Arena can be assembled to create large hanging or a free-standing base from which to build the foundations of an imposing and solid stand structure. These can then be dressed in durable eyeleted PVC, held in place on the display by bungee cord.



No matter what sort of space you are dealing with, or what your communications objectives are, we have a Modular solution that will meet your requirements.

Choose from our standard kits or work with our CAD Designers to create a custom stand that perfectly suits your needs.

Once created, our kits assemble quickly and easily with a choice of custom graphic solutions.

Services available

From an initial design briefing to production of inspiring concepts, to fully-specified stands, we can design, quote and build a display solution that meets your exact requirement as a full end-to-end service.



3D CAD Design

Our design team offers standard and bespoke display solutions. We have an extensive parts library to suit your specification and individual items, such as literature holders to complete modular stand designs.



Concepts and Quotation

Our experienced team will craft the solution to your exact requirements.



Prebuild

Manufacturing is completed in our own production facilities across Europe. Clients are invited to inspect pre-build stands before they are shipped.



Graphics

Our large-scale print facilities can provide all your graphics to suit your needs.

Why choose a modular solution?

- Economics
- Aesthetics
- Ease of assembly
- Compact for easy shipment to multiple points of sale
- Standard or custom
- Unlimited renewal of brand message by simply changing the graphics



Formulate



The Formulate stand displays have no limits. This concept, although part of a wider range of POS displays, is a structure that brings brands and events to life in a more unique three dimensional way.

Custom fabric printing, by nature, allows exploring new graphic and shaped possibilities. The graphics are dye-sub printed onto specifically selected media that perfectly fits the unique shaped contours made by Formulate structures. Formulate is light weight, easy to set up and a compact package to carry.

Manufactured to order.



Aluminium tubes are Ø30 and Ø50mm



Easy matching system



Push-fit button assembly



Double-sided tension fabric graphics that zips closed



Structures are free-standing or use stabilising feet



Suspension hooks for hanging structures



Hanging structures can also be backlit

NEW

Structures disappear leaving original and innovative forms in their place

A simple, intuitive solution that is easy to set up in any situation. Formulate products are available in banner configurations, backwalls from 3 to 9m wide, columns, arches, hanging signs ... and custom made.



Free-standing columns available in varying heights

Free-standing structures

Simplicity, stability and originality are the key words that characterise Formulate free-standing structures. Available in various shapes and sizes, these structures highlight brand messaging using vibrant custom tension fabric graphics.



Accessorise your backwalls and give them more impact



Stabilising feet at regular intervals



Simple assembly

Large format display

Possibility to accessorise

Greater impact and visibility



For Formulate accessories please see page 86 .



Ideal for partitioning spaces

The primary goal of Formulate is to provide you with a layout solution where traditional wood or aluminium angular structures can be limited. Formulate allows you to be creative as the aluminium tubes can be curved to your imagination.

Hanging Structures

Formulate Hanging Structures have been specially designed to allow easy installation in complete safety.

The lightness of aluminium tubular structures makes them ideal for dressing up an exhibition stand, a commercial gallery or an indoor reception or walkway.



Available from Spring 2019



Optional back lighting available

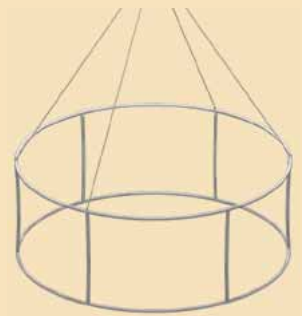

Finishing for Hanging Structures

Complete your hanging structure with a custom printed graphic. As well as adding a brand message to the outer structure you can also brand the inside, leave it plain or add a pattern or another message!



Customise the interior and exterior of your hanging structures



Double-sided graphics



Custom made hanging structures also available

Stands

Formulate stands are composed of structures with original and unique modern forms. Their creative style enables messages to be highlighted.

The manufacture of tubular structures in the Formulate range requires a range of production techniques (cutting, welding, bending for example). Once dressed with custom printed fabric graphics, Formulate offers endless possibilities of unique customisation.

Combine curved and straight shapes to create unique forms for your structures



Bring depth and perspective to your stand with arches and stand off structures



Self-supporting arches offer double-sided customisation for double the brand impact



Custom Formulate shapes are a great way to stand out

Custom Made



Original shapes that adapt to all environments

The ability to bend and cut tubular structures, combined with the use of a custom printed stretch fabric graphics, makes it possible to create custom made solutions for stand and layout furniture with infinite possibilities. Custom creations are made on demand and optimise the return on investment by deploying brands in the most suitably creative display solution.



Modulate™



Inspired by the Formulate concept, Modulate™ is composed of a set of 11 frames made from Ø30mm aluminium tubes and dressed with a custom printed tension fabric graphic. These frames can easily connect to each other using powerful magnets placed inside each structure.

Based on this simple magnetic principle, it is possible to combine the various Modulate™ frames to create configurations for all communication fields: point of sale, trade shows, exhibition venues, shopping centres, conferences or simply within company reception or welcoming areas or office spaces.

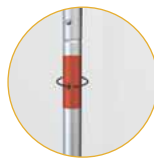

360° MagLink connectors in each pole



Simple assembly with numbered frame parts



Bungeed tubing with push-fit locking buttons

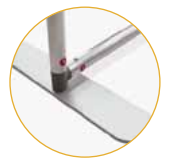

Stabilising feet with Twist & Lock system

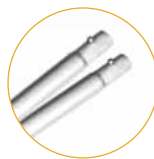

Optional 400mm extension to change structure height



Double-sided custom printed graphic



Central reinforcement bar (Ø18mm)



Transport bag with dedicated pockets for feet and the graphics

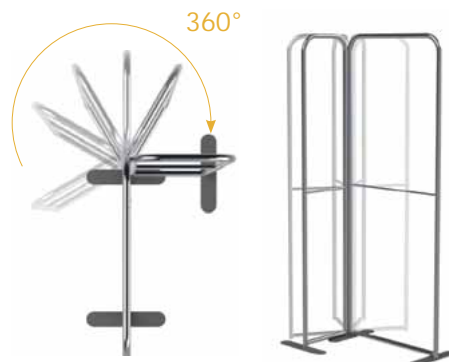

MagLink connectors make it easy to place your frames at any angle you want



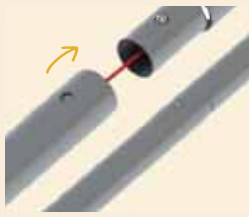

Assemble frames using the bungeed tubes and push-fit buttons



Add the central reinforcement bars and connect all the tubes using the easy matching system



Place the Twist & Lock foot under the structure and rotate it to lock it



Use the gloves provided with the structure to manipulate the visual and slide it on the frame

Versatile scalable configurations

I deal for quick changes in the retail environment



Reconfigurable stands



Create new workspaces



Mix & Match

Choose your frames from the sizes and shapes offered and join them magnetically at any angle with the internal patent pending MagLink system. Combine any number of frames and mix at will to make new configurations instantly - Modulate™ can evolve according to your display needs from a simple backwall to free-standing columns or an innovative exhibition stand in minutes!



Vector



Because businesses and projects evolve, the Vector aluminium frame system with SEG custom printed graphics lends itself perfectly and stands out as one of the most simple and versatile communication solutions on the market.

The Vector range is highly versatile and offers optimal visual impact for original designs that adapt to many environment: showrooms, retail outlets, exhibitions, museums amongst others and can be manufactured to order.



Eight aluminium profiles



Custom printed SEG graphic



Simple and quick assembly



Easy matching system



Accessories



LED strips are pre-assembled in frames



Choice of stabilising feet



13 Vector frame modules

Free-standing Frames



Single or double-sided free-standing frames with integrated LED lighting

Hanging Structures



Metal hooks attach to the structure for ease of suspending

Modular Stands



Combine rounded and straight angles for full graphic visibility



Scalable solutions that suit your needs and budget

From free-standing backwalls to exhibition shell schemes or stands, Vector Modules offer you versatile designs that adapt to all types of events and spaces. Combine our thirteen stock Vector modules to create innovative stand solutions which give you the freedom to re-develop your stand as often as you need to. This guarantees an excellent return on investment from the ability to update, extend or add structures or custom printed graphics for a new brand message or stand design or configuration.

Each module is manufactured with 50mm aluminium profiles and cut into 1.25m sections for ease of storage and transportation.



Linear



The Linear range is ideal for free-standing graphic backwall applications, full stands or even office furniture. It is composed of aluminium profiles that form the basis of a solid and durable structure, either for permanent or temporary usage.

Linear is a modular solution consisting of different profiles created as an alternative to structures with just stretch fabric graphic cladding. Linear structures can also accommodate a versatile array of custom graphic alternatives such as rigid panel graphics as well as roll-able PVC custom printed graphics too.

The construction is based on posts with channels and reinforcing beams which allow you to equip your structures with said graphics.

Manufactured to order.



Range of 6 posts and 2 beams



Coded system for ease of assembly

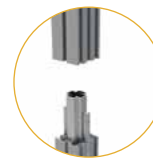

Simple male and female Linear post connections



Allen key assembly and locking



PVC graphic affixed with magnetic tape



Choice of stabilising feet



Choice of accessories



Five Linear modules



I deal for the use of soft or rigid PVC custom printed graphics



Free-standing Frames



Backwalls



Modular Stands

Adapt your stand according to your space and requirements.

The Linear display system is available in five modules that can be combined to create multiple different configurations.

The posts are cut into 1.25m sections, for ease of transportation and storage or ready for use with your custom printed graphic.



Change the size of your stand quickly and easily by combining different modules



Arena



If your project requires a sturdy, larger scale solution, then choose Arena.

This is a tubular 25mm aluminium frame structure that is highly stable yet is still a scalable display solution. The different sections can be assembled and re-used according to the needs of each project.

- Tubular aluminium frame 25mm diameter (approx)
- Straight sections available in nine different lengths
- Supports up to 100kgs over a 2m span
- Use in structures up to 6m long without a down section
- Graphics attach by bungee fixings
- Structure is assembled with bolt and wing-nut fixings
- Tool-less assembly

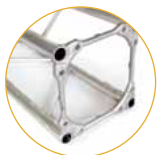

Straight or curved sections



Multi-directional connectors



Tool-free assembly



Accessories

Can be used with printed vinyl or fabric graphics



Economical re-usable and reconfigurable structures



Use free-standing



Literature Holders

Being able to display your literature in a way that encourages your visitor or customer to look and take it away is always the main challenge facing Marketeers!

Our literature holders come in a variety of sizes and forms to give the greatest choice available. Literature completes your display and we provide a choice of stylish literature holders to suit any display situation – available in a range of materials and finishes including aluminium, polycarbonate and injection moulded.

Portable, lightweight
and easy to use



Solution Systems



Double-sided

Quantum



Perfect combination of classic design with a stylish look. Literature can be left in tray when unit is folded flat.

Material :	ABS plastic (trays), powder coated steel (arms/base)
Colour:	Smoked grey
Documents sizes :	A4
Pockets :	Five
Double-sided :	Yes
Transport :	Foamed premium bag (included)

Quantum A4	AS316-01	📏 1320 (h) x 285 (w) x 380 (d) mm
------------	----------	-----------------------------------



Ultra compact



Cascade



Robust and lightweight model. The one-step cantilever assembly makes it collapsible for easy transportation.

Material :	Polymer, polycarbonate
Colour:	Grey
Documents sizes :	A4
Pockets :	Four
Double-sided :	No
Transport :	Premium fabric bag (included)

Cascade A4	AS320	📏 1480 (h) x 265 (w) x 310 (d) mm
------------	-------	-----------------------------------



Automatically locks in open or folded position



Zed-Up Lite



Popular range of aluminium literature stands that are stylish and highly portable. Folds down for easy transportation in a heavy duty hard case.

Material :	Acrylic and anodised aluminium
Colour :	Silver
Documents sizes :	A5 / A4 / A3
Pockets :	Six
Double-sided :	Yes
Transport :	Hard case (included)

A5 (6 Pockets)	AS318-002	📏 1115 (h) x 210 (w) x 280 (d) mm
A4 (6 Pockets)	AS315-002	📏 1460 (h) x 256 (w) x 370 (d) mm
A3 (6 Pockets)	AS319-002	📏 1420 (h) x 470 (w) x 370 (d) mm



Safe transportation in hard case



Xanadu



Basic fabric literature holder with stabilising foot and bungee pole. Great lightweight option. Three pieces construction.

Material :	Fabric, aluminium
Colour:	Black
Documents sizes :	A4
Pockets :	Four / eight
Double-sided :	No
Transport :	Fabric bag (included)

4 pockets	WH431	📏 1365 (h) x 280 (w) x 380 (d) mm
8 pockets	WH432	📏 1365 (h) x 560 (w) x 380 (d) mm

Four or eight pocket options

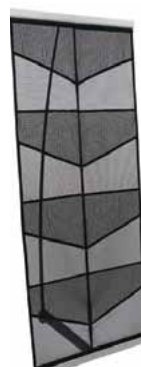

Cost effective solution

Carry bag included



CNC available for custom shaped graphics (Optional extra)

Linear Media Post



A robust, handy and very versatile graphic and literature holder which allows you to display information and promotion at the same time.

Material :	Anodised aluminium post, steel dome base
Colour :	Silver
Documents sizes :	A4
Pockets :	Three - included
Graphic :	Single or double-sided
Graphic :	Optional extra - ideal with 5 mm foamed PVC
Transport :	Carry bags (optional extra)

Linear Media Post	LK026-001	📏 2060 (h) x 523 (w) x 450 (d) mm
-------------------	-----------	-----------------------------------

Accessories :

Base bag	AB910
Pole bag	AB293

Adjustable
A4 Literature
holders



Injection Moulded Literature Holder



Aesthetic and versatile literature holder which can be mounted to Linear (direct mounting), Vector, Aero+ and Formulate stands (with optional universal clamp) or wall mounted.

Material :	Injection moulded plastic
Colour :	Smoked light grey
Documents sizes :	A4 / A5 / DL
Pockets :	One
Double-sided :	No

A4	AH5A4P	📏 330 (h) x 254 (w) x 55 (d) mm
A5	AH5A5P	📏 250 (h) x 182 (w) x 45 (d) mm
DL	AH5DLP	📏 250 (h) x 132 (w) x 45 (d) mm



Suitable for wall mounting or mounting on the back, right or left of the post side



Cases

We know that using lightweight luggage to transport your structures and visuals helps to make your work easier.

Our range of bags and cases are made of flexible and rigid materials adapted to your specific transport or storage needs.

Linear



Extra strong, large moulded case for transporting Linear or Vector extrusion and kits. Optional configurable cardboard inserts for controlled storage. Complete with support straps for extra security.

Material : Medium-density polyethylene (MDPE), aluminium handles
 Wheels : Two
 Handle : Two
 Stackable : Yes - 5 max

Linear	AC506	1300 (h) x 740 (w) x 360 (d) mm <small>(external size)</small>
Linear (No compartments)	AC506-001	1300 (h) x 740 (w) x 360 (d) mm <small>(external size)</small>



Cardboard interior compartments



Strong aluminium handle



Option to compartmentalise the inside

Graphic Drum



Comes in a range of sizes to enable you to transport graphics safely and securely. Manufactured from tough, lightweight polyethylene. Available in two heights and two diameters.

Material : Polyethylene
 Wheels : No
 Handle : One
 Stackable : No

Graphic Drum 850 (h) mm	AC305	850 (h) x 400 (Ø) mm
	AC306	850 (h) x 300 (Ø) mm
Graphic Drum 1020 (h) mm	AC365	1020 (h) x 400 (Ø) mm
	AC366	1020 (h) x 300 (Ø) mm



Carry handle



Secure fastening

Up to five graphic drops*

Up to ten graphic drops*



Ø 300mm



Ø 400mm

Ideal for transporting graphics

* Depending on media thickness

Zenith



The new height extendable tough moulded polyethylene Zenith standard and tall cases offer a multitude of features.

Versatile

Ideal ultra-portable transport solution with maximum storage for pop-ups, backwalls, roller banners and extrusions, they also double up as counters with optional extra graphic wrap and table top.

Scalable

The standard case will house a 3x5 pop-up system and graphics. The optional 100 mm high extension creates a taller configuration which can house 850mm wide roller banners.

Secure

Internal dividers to protect graphics are included and the case can be locked using padlocks (not supplied).

One case, extendable to three heights!



- Material : Medium-density polyethylene (MDPE) / Metal
- Wheels : Two
- Handle: One
- Stackable : No
- Table top: Optional extra (Beech / black / silver / white)
- Graphic wrap : Optional extra
- iPad holder : Optional extra (Black / white)

Zenith standard case	AC600	956 (h) x 600 (w) x 400 (d) mm <small>(external size)</small>
Zenith tall case (Standard + 1x extension)	AC601	1056 (h) x 600 (w) x 400 (d) mm <small>(external size)</small>



Accessories :		
Extension (use 2 max)	ZNTH-EXT	100 (h) x 600 (w) x 400 (d) mm
Table top (beech)	CO401-C	15 (h) x 640 (w) x 420 (d) mm
Table top (white)	CO401-W	15 (h) x 640 (w) x 420 (d) mm
Table top (black)	CO401-B	15 (h) x 640 (w) x 420 (d) mm
Table top (silver)	CO401-S	15 (h) x 640 (w) x 420 (d) mm
iPad holder (white)*	CO401-IPW	25 (h) x 420 (w) x 640 (d) mm
iPad holder (black)*	CO401-IPB	25 (h) x 420 (w) x 640 (d) mm



Foam protected lid holds 2x LED lights



Optional extensions stack two high



Removable internal divider



Optional table top and iPad holder*

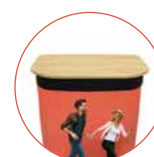

Optional graphic wrap and table top

Table top available in four colours



* Not available for standard beech table top



Carry Bags



Large range of fabric bags to carry or store panel systems, banners, portable furniture and literature racks.

Carry Bags	Contact us	Standard or Custom
------------	------------	--------------------



Available in custom sizes



Polypropylene Cases



Cost-effective strong polypropylene cases. Optional extra wheels and padding available on some cases.

Can store or transport graphics, panels, Pop-ups, and literature stands.

Polypropylene Cases	Contact us	Standard or Custom
---------------------	------------	--------------------



Pop-up Frame Fabric Bag



Protect your Pop-up frame by transporting or storing in a lightweight carry bag. Takes up to 3x4 frame size. Carry handle on top of bag.

Pop-up Frame Bag	AB105	770 - 1250 (h) x 115 (Ø) mm
------------------	-------	-----------------------------



Padded Lighting Bag



Foamed lightweight fabric bag, suitable for transporting two of the following lights; PS950-1000 LED, or LED Flood / Strip / Exhibition lights. Zipped with carry handles.

Padded Lighting Bag	AB101	570 (h) x 180 (w) x 120 (d) mm
---------------------	-------	--------------------------------



Graphic Banner Tube



Lightweight fabric bag with internal cardboard tube and shoulder strap offering extra protection during transportation. Also available without the tube on request.

Graphic up to 850 (h) mm	AB120M	880 (h) x 155 (Ø) mm
Graphic up to 1050 (h) mm	AB120AM	1080 (h) x 155 (Ø) mm
Graphic up to 1250 (h) mm	AB120CM	1280 (h) x 155 (Ø) mm
Graphic up to 1550 (h) mm	AB120DM	1580 (h) x 155 (Ø) mm



Mag Bar Bag



Keeps Pop-up mag bars safe and clean while in transit or after use in storage. Fabric bag with hook and loop locking system, complete with carry handle. Capacity to house up to 21 mag bars.

Mag Bar Bag	AB104	735 (h) x 110 (h) x 70 (d) mm
-------------	-------	-------------------------------

Lighting

Make your displays come alive with great lighting that attracts attention.

Focus attention on the elements of your display that you want to highlight from our range of LED lighting.



LED Lighting

LED technology saves energy, does not overheat and lasts longer.

- > Our LED lighting has been designed specially to adapt to display and stand solutions
- > Provide better efficiency with increased lighting at lower power consumption
- > Meets safety standards and CE certified

Measuring Light: Watts and Lumens Explained

Traditionally we have measured light in watts, however watts are a measurement of power and not light output. With the emergence of new and more efficient LED technology, lumens (lm) are the preferred measurement of light.

One lumen is equivalent to the light emitted from one wax candle. For example; a traditional 40 watt light bulb has a lumen output of approximately 450lm. Our mix and match range of LED lights below have a lumen of 1200 but only use 12 watts of energy. They still give off bright white light, but use only a fraction of the energy compared to traditional halogen lights.

Perfect for illuminating larger displays

Our high-end LED spotlights are designed to illuminate large exhibition areas and backwalls

- Material : Aluminium / plastic
- Watt output : 80 watt
- Watt consumption : 12 watt (1200 lumens)
- Single kit includes : One spotlight + 2.5m linking lead
- Double Kit includes : Two spotlights + 2.5m linking lead + 1 transformer
- Linked lights : Link up to five to one transformer
- Power lead UK & Euro: Yes (cross head screwdriver needed)

Link up to five LED lights (maximum)

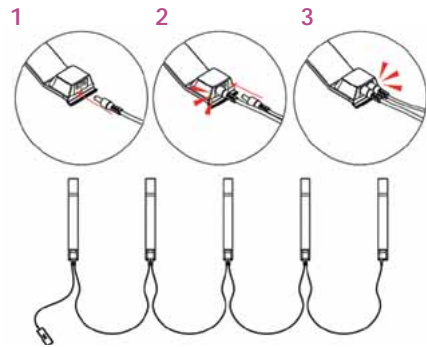

Heads swivel for perfect positioning

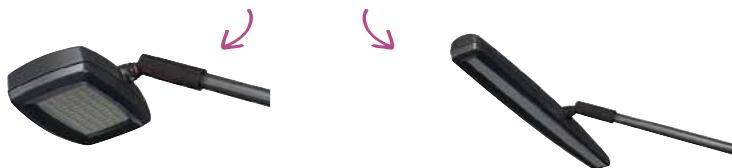

I deal for modular stands

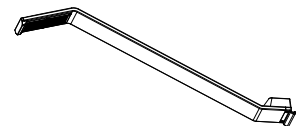
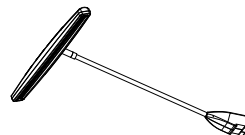
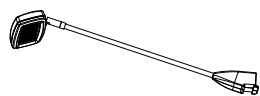

LED Floodlight



Single Kit	LED-FLOOD-ARM-B
Double Kit	LED-FLOOD-ARM-BDLK
Transformer*	LED-ARM-TRANS

LED Strip Light



Single Kit	LED-STRIP-ARM-B
Double Kit	LED-STRIP-ARM-BDLK
Transformer*	LED-ARM-TRANS

LED Exhibition Light



Single Kit	LED-EXHIB-ARM-B
Double Kit	LED-EXHIB-ARM-BDLK
Transformer*	LED-ARM-TRANS



Powerspot 50 LED



This silver clamp fixing LED has been designed to work specifically with panel systems. 360° adjustable head.

Material :	Aluminium / plastic
Watt output :	5 watt (475 lumens/3000 Kelvins)
Single kit includes :	One spotlight with 3m lead
Linked lights :	No
Power lead UK & Euro:	Yes (cross head screwdriver needed)

Powerspot 50 LED	PS050-LED
------------------	-----------



Powerspot 800 LED



Silver and white LED with integral bulldog clip for affixing to 16mm banner stand poles. Comes with curved arm and 180° adjustable head.

Material :	Aluminium / plastic
Watt output :	5 watt (520 lumens/5000 kelvins)
Single kit includes :	One spotlight GU10 LED bulb
Linked lights :	No
Power lead UK & Euro:	Yes (cross head screwdriver needed)

Powerspot 800 LED	PS800-LED
-------------------	-----------



Powerspot 950/1000 LED



Great black LED suitable for Pop-up systems with straight arm and 270° adjustable head.

Material :	Aluminium / plastic
Watt output :	12 watt (1400 lumens/5500 kelvins)
Single kit includes :	One spotlight
Linked lights :	Yes - Two
Power lead UK & Euro:	Yes (cross head screwdriver needed)

Single Kit	PS950-1000-B
Double Kit	PS950-1000-BDLK



Clip on to pop-up end panels

Powerspot 1200



Fluorescent clip on light suitable for illuminating Pop-up end panels with straight arm and 270° adjustable head.

Material :	Metal / plastic
Watt output :	20 watt fluorescent light - NOT LED
Single kit includes :	One light with 2m lead
Linked lights :	Yes - US601B
Power lead UK & Euro:	Yes (cross head screwdriver needed)

Powerspot 1200 LED	PS1200
--------------------	--------

Convert your UK plug into EU version



Fixing for 30mm Ø tubing



Transparent fixing that fits on to Formulate and Modulate structures that use 30mm diameter tubing for accessorising with lighting or rigid panels.

Material : Metal, plastic
Compatible : 30mm diameter tubing
Mounting : Allen key



Discrete fixing

Fixing for 30mm Ø tubing	US903
--------------------------	-------

Recommended Fixings for Lighting

Integrated fixing						
	Universal Fixing Kit US901-C	Vector Fitting VLF	Linear Fitting US-LINEAR	Hop-up Fitting HUILF	LED Fitting for Quick+ US902-C	30mm Ø Tube Clamp US903

Compatible with :

	Spot LED Flood LED-FLOOD-ARM-B	> Aero > Stealth > Quick+ > Embrace > Linear > Vector	> Impact > Formulate > Arena > Gear Edge Panels > Baseline Panels			> Hop-up > Xclaim	> Impact > Quick+	> Formulate > Modulate
	Spot LED Strip LED-STRIP-ARM-B	> Aero > Stealth > Quick+ > Embrace > Linear > Vector	> Impact > Formulate > Arena > Gear Edge Panels > Baseline Panels			> Hop-up > Xclaim	> Impact > Quick+	> Formulate > Modulate
	Spot LED Exhibition LED-EXHIB-ARM-B	> Linear > Vector						
	Powerspot 50 LED PS050-LED	> Gear Edge Panels > Baseline Panels > Phantom Panels						
	Powerspot 800 LED PS800-LED	> Roller Banners						
	Powerspot 950-100 LED PS950-1000-B	> Impact > Embrace > Quick+ (Except Quick+ tower)	> Formulate > Arena	> Vector	> Linear	> Hop-up > Xclaim	> Hop-up > Xclaim	> Formulate > Modulate
	Powerspot 1200 PS1200	> Impact > Quick+						

Custom and Made to Measure

To guarantee quality visuals that are adaptable for multiple uses, we have selected a wide range of print media for you.

From conception to finish, we guarantee a perfect fit and good quality vibrant printed custom graphics.

If you want a special format or finish, we invite you to contact one of our advisers for a custom-made quote.

Below are suggestions for frequently used custom graphics.



Security Barrier
Fastening by eyelets (bungee not provided)



Table Cloth
With hem



Anti-theft security cover
Graphic Cover



Horizontal flag
Loop fastening with rings round

Custom shapes available



Vertical flag
Straps and hooks fastening

Other suggestions

Ask us for about other custom made graphics you require





Media Specifications and Colours

The colours shown on this page are given as an indication only.
 In order to find the desired colour more easily, PDF swatches are available on request.

Standard Loop Nylon	Luxury Foam Backed Nylon	Smooth (Formerly Prelude)
<ul style="list-style-type: none"> Blue Navy Quince Green Bottle Green Emerald Green New Silver Grey Dove Black Cherry Red Burgundy Primrose Wedgewood Royal Blue Regal Blue 	<ul style="list-style-type: none"> Ink Navy Emerald Green Quince Green Bottle Green Medici New Grey Black Gunmetal Plasma Red Saffron Steel Blue Pacific Dark wine 	<ul style="list-style-type: none"> Platinum Eclipse Storm Electric blue Aegean Royal Flame

Colours for Shelves and Counter Tops

- Beech
- Black
- Silver
- White





DISPLAY

Your Complete
Visual Communication
Display Guide